

# Digital Counter H7CZ



## Easy to Use and Easy to Read.

### Basic Features

- Character height of 10 mm for better readability.
- Operation is simplified by the Up Key for each digit.

### Safety and Reliability

- Power supply circuit and input circuits are isolated inside the Counter.
- Set value limit function prevents unexpected operation of output devices caused by setting mistakes.
- Output counter function helps in managing the service life of the Counter or the load.

### Other Features

- Waterproof, dust-proof structure (UL508 Type 4X and IP66).
- Key protection.

 Refer to *Safety Precautions* on page 17.



**NEW**

For the most recent information on models that have been certified for safety standards, refer to your OMRON website.

## Features

### Basic Features

#### Better Readability

Character Height of 10 mm with a Wide Viewing Angle.

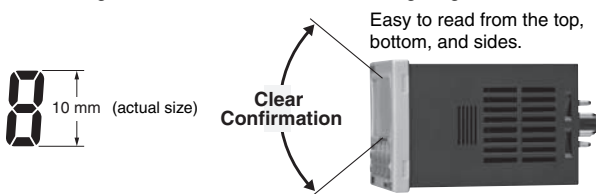

#### The Easiest Operation

Operation is simplified by the Up Key for each digit.



### Set Value Limit

You can set an upper limit for the set value to prevent unexpected operation of output devices caused by setting mistakes.

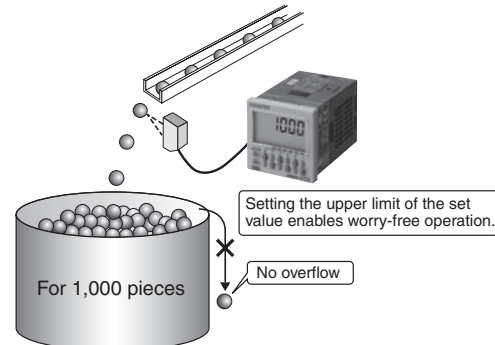

### Output Counter

The output counter counts the number of times the output turns ON (alarms can be displayed and the count can be monitored in increments of 1,000 operations). This counter is useful in managing the service life of the Counter or the load.

### Other Features

#### Waterproof, Dust-proof Structure (UL508 Type 4X and IP66)

Worry-free application is possible in locations subject to water.

**Note:** When the Y92S-29 Waterproof Packing is used.

### Key Protection

Select from any of seven protection patterns. Use the best one for the application.

### Safety and Reliability

#### Isolated Power Supply and Input Circuits

Power supply circuit and input circuits are isolated inside the Counter. Previous non-isolated counters had wiring restrictions and could be damaged if wired incorrectly. The H7CZ removes these worries.

# H7CZ

## Model Number Structure

### Model Number Legend

H7CZ-L□□  
1 2

#### 1. External connections

Symbol	Meaning
8	8-pin socket

#### 2. Supply voltage

Symbol	Meaning
None	100 to 240 VAC at 50/60 Hz
D1	12 to 24 VDC/24 VAC at 50/60 Hz

## Ordering Information

### List of Models

Type	Configuration	External connections	Settings	Display digits	Outputs	Power supply voltage	Model
H7CZ	• 1-stage preset counter	8-pin socket	1-stage	6 digits	Contact output (SPDT)	100 to 240 VAC	<b>H7CZ-L8</b>
						12 to 24 VDC/24 VAC	<b>H7CZ-L8D1</b>

**Note:** The functions that are provided depend on the model. Check detailed specifications before ordering.

## Accessories (Order Separately)

### Soft Cover

Model	Page
Y92A-48F1	9

### Hard Cover

Model	Page
Y92A-48	9

### Flush Mounting Adapter

Model	Page
Y92F-30	9

### Waterproof Packing

Model	Page
Y92S-29	9

### Connection Sockets

Model	Type	Remarks	Page
P2CF-08	Front-connecting Socket	---	10
P2CF-08-E	Front-connecting Socket (Finger-safe Type)	Round crimp terminals cannot be used on Finger-safe Sockets. Use forked crimp terminals.	
P3G-08	Back-connecting Sockets	A Y92A-48G Terminal Cover can be used with the Socket to create a finger-safe construction.	

### Terminal Covers for P3G-08 Back-connecting Socket

Model	Page
Y92A-48G	10

H7CZ Multifunction Preset Counter
-----------------------------------

## Specifications

### Ratings

Item	Models	H7CZ-L8	H7CZ-L8D1
<b>Configuration</b>		1-stage preset counter	
<b>Ratings</b>	<b>Power supply voltage *1</b>	100 to 240 VAC, 50/60 Hz	24 VAC, 50/60 Hz or 12 to 24 VDC
	<b>Operating voltage fluctuation range</b>	85% to 110% of rated supply voltage (12 to 24 VDC: 90% to 110%)	
	<b>Power consumption</b>	Approx. 9.4 VA at 100 to 240 VAC, Approx. 7.2 VA/4.7 W at 24 VAC/12 to 24 VDC	
<b>Mounting method</b>		Flush mounting or surface mounting	
<b>External connections</b>		8-pin socket	
<b>Degree of protection</b>		IEC IP66, UL508 Type 4X (indoors) for panel surface only and only when Y92S-29 Waterproof Packing is used.	
<b>Input signals</b>		Count, Reset	
<b>Counter</b>	<b>Maximum counting speed</b>	30 Hz or 10 kHz (switchable) (ON/OFF ratio 1:1)	
	<b>Input mode</b>	Increment, Decrement	
	<b>Output mode</b>	N, F, C, R, K-1, P, Q, and A.	
	<b>One-shot output time</b>	0.01 to 99.99 s	
	<b>Reset system</b>	External (minimum reset signal width: 1 ms or 20 ms, selectable), Manual, and Automatic reset (internal according to C, R, P, and Q mode operation)	
<b>Prescaling function</b>		Yes (0.001 to 99.999)	
<b>Decimal point adjustment</b>		Yes (rightmost 3 digits)	
<b>Sensor waiting time</b>		290 ms max. (Control output is turned OFF and no input is accepted during sensor waiting time.)	
<b>Input method</b>		No-voltage inputs: ON impedance: 1 kΩ max. (Leakage current: 12 mA at 0 Ω) ON residual voltage: 3 V max. OFF impedance: 100 kΩ min.	
<b>Control output</b>		3 A at 250 VAC/30 VDC, resistive load (cosφ=1), Minimum applied load: 10 mA at 5 VDC (failure level: P, reference value)	
<b>Display *2</b>		LCD Character height Count value: 10 mm Set value: 6 mm	
<b>Digits</b>		6 digits -99999 to 999999 (-5 digits to +6 digits)	
<b>Memory backup</b>		EEPROM (overwrites: 100,000 times min.) that can store data for 10 years min.	
<b>Operating temperature range</b>		-10 to 55°C (-10 to 50°C if Counters are mounted side by side) (with no icing or condensation)	
<b>Storage temperature range</b>		-25 to 70°C (with no icing or condensation)	
<b>Operating humidity range</b>		25% to 85%	
<b>Front panel color</b>		Light gray (5Y7/1)	

\*1. Do not use the output from an inverter as the power supply. The ripple must be 20% maximum for DC power.

\*2. The display is lit only when the power is ON. Nothing is displayed when power is OFF.

## Characteristics

<b>Insulation resistance</b>	100 MΩ min. (at 500 VDC) between current-carrying terminals and exposed non-current-carrying metal parts, and between non-continuous contacts	
<b>Dielectric strength</b>	2,000 VAC, 50/60 Hz for 1 min between current-carrying metal parts and non-current-carrying metal parts 2,000 VAC, 50/60 Hz for 1 min between power supply and input circuit (1,000 VAC for 24 VAC/12 to 24 VDC) 1,000 VAC, 50/60 Hz for 1 min between control output, power supply, and input circuit (2,000 VAC) 1,000 VAC, 50/60 Hz for 1 min between non-continuous contacts	
<b>Impulse withstand voltage</b>	3.0 kV between power terminals (1.0 kV for models with 24 VAC/12 to 24 VDC) 4.5 kV between current-carrying terminals and exposed non-current-carrying metal parts (1.5 kV for models with 24 VAC/12 to 24 VDC)	
<b>Noise immunity</b>	±1.5 kV between power terminals ±600 V between input terminals Square-wave noise by noise simulator (pulse width: 100 ns/1 μs, 1-ns rise)	
<b>Static immunity</b>	Malfunction: 8 kV Destruction: 15 kV	
<b>Vibration resistance</b>	<b>Destruction</b>	10 to 55 Hz with 0.75-mm single amplitude each in three directions for 2 h each
	<b>Malfunction</b>	10 to 55 Hz with 0.35-mm single amplitude each in three directions for 10 min each
<b>Shock resistance</b>	<b>Destruction</b>	300 m/s <sup>2</sup> each in three directions
	<b>Malfunction</b>	100 m/s <sup>2</sup> each in three directions
<b>Life expectancy</b>	Mechanical: 10,000,000 operations min. Electrical: 100,000 operations min. (3 A at 250 VAC, resistive load, ambient temperature condition: 23°C)*	
<b>Weight</b>	Approx. 100 g (Counter only)	

\* Refer to the Life-test Curve.

## Applicable Standards

<b>Approved safety standards</b>	cULus (or cURus): UL508/CSA C22.2 No. 14 * <sup>1</sup>	
	EN 61010-1 (IEC 61010-1): Pollution degree 2/overvoltage category II B300 PILOT DUTY 1/4 HP 120 VAC, 1/3 HP, 240 VAC, 3 A resistive load VDE0106/P100 (finger protection)	
<b>EMC</b>	(EMI)	EN61326-1 * <sup>2</sup>
	Emission Enclosure:	EN 55011 Group 1 class A
	Emission AC mains:	EN 55011 Group 1 class A
	(EMS)	EN61326-1 * <sup>2</sup>
	Immunity ESD:	EN 61000-4-2: 4 kV contact discharge; 8 kV air discharge
	Immunity RF-interference:	EN 61000-4-3: 10 V/m (Amplitude-modulated, 80 MHz to 1 GHz); 10 V/m (Pulse-modulated, 900 MHz ±5 MHz)
	Immunity Conducted Disturbance:	EN 61000-4-6: 10 V (0.15 to 80 MHz)
	Immunity Burst:	EN 61000-4-4: 2 kV power-line; 1 kV I/O signal-line
Immunity Surge:	EN 61000-4-5: 1 kV line to lines (power and output lines); 2 kV line to ground (power and output lines)	
Immunity Voltage Dip/Interruption:	EN 61000-4-11: 0.5 cycle, 100% (rated voltage)	

\*<sup>1</sup>. The following safety standards apply to H7CZ.

cUL (Listing): Applicable when an OMRON P2CF(-E) Socket is used.

cUR (Recognition): Applicable when any other socket is used.

\*<sup>2</sup>. Industrial electromagnetic environment (EN/IEC 61326-1 Table 2)

## I/O Functions

### Using as a Counter \*<sup>1</sup>

<b>Inputs</b>	<b>Count</b>	<ul style="list-style-type: none"> <li>Reads counting signals.</li> <li>Increment and decrement inputs accepted.</li> </ul>
	<b>Reset</b>	<ul style="list-style-type: none"> <li>Resets present value and outputs.*<sup>2</sup></li> <li>Counting cannot be performed during reset input.</li> <li>Reset indicator is lit while reset input is ON.</li> </ul>
<b>Outputs</b>	<b>OUT</b>	Outputs signals according to the specified output mode when a set value is reached.

\*<sup>1</sup>. For information on operation of I/O functions, refer to page 14 and page 15.

\*<sup>2</sup>. In elapsed time mode, the present value returns to 0; in remaining time mode, the present value returns to the set value.

- The following table shows the delay from when the reset signal is input until the output is turned OFF. (Reference values)

Minimum reset signal width	Output delay time
1 ms	0.8 to 1.2 ms
20 ms	15 to 25 ms

## Life-test Curve (Reference Values)

### Resistive load

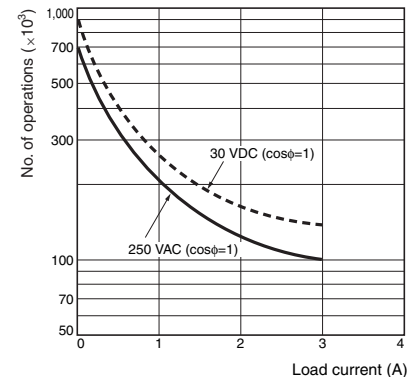

### Inductive load

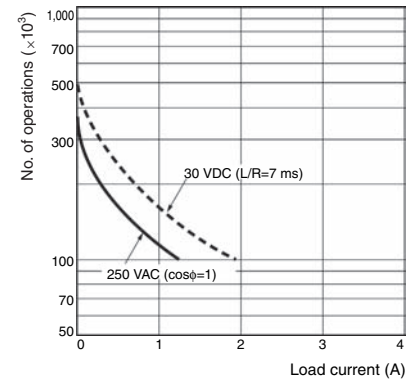

A current of 0.15 A max. can be switched at 125 VDC (cosφ=1) and current of 0.1 A max. can be switched if L/R=7 ms. In both cases, a life of 100,000 operations can be expected.

# Connections

## Block Diagram

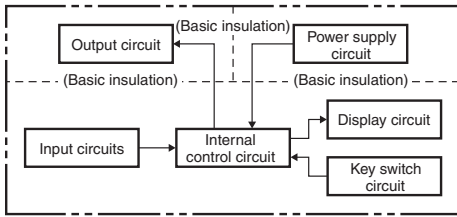

## Input Circuits

### Count and Reset Input

#### No-voltage Inputs (NPN Inputs)

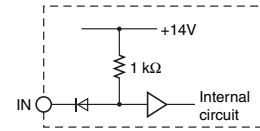

## Terminal Arrangement

Confirm that the power supply meets specifications before use.

### H7CZ-L8/L8D1

#### 1-stage Contact Output

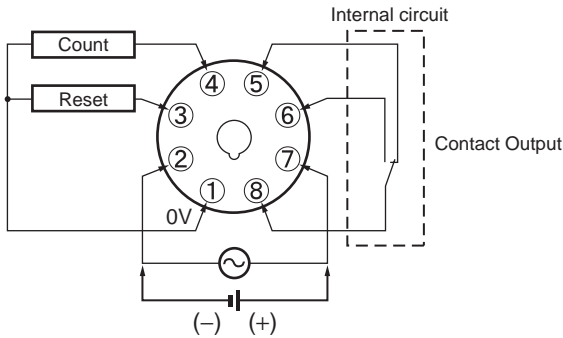

## Input Connections

The inputs of the H7CZ-L8□ are no-voltage (short-circuit or open) inputs.

### No-voltage Inputs (NPN Inputs)

#### Open Collector

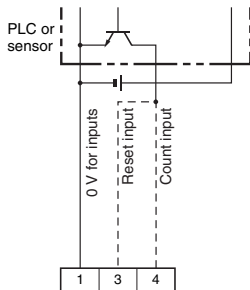

Note: Operates with transistor ON.

#### Voltage Output

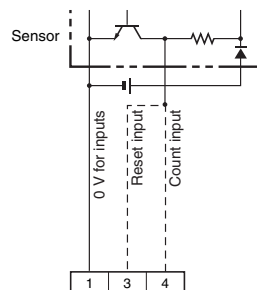

Note: Operates with transistor ON.

#### Contact Input

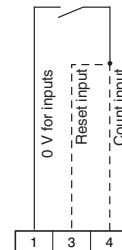

Note: Operates with relay ON.

#### DC Two-wire Sensor

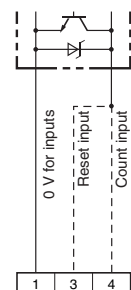

Note: Operates with transistor ON.

### No-voltage Input Signal Levels

<b>No-contact input</b>	Short-circuit level (transistor ON)
	<ul style="list-style-type: none"> <li>Residual voltage: 3 V max.</li> <li>Impedance when ON: 1 kΩ max.</li> </ul> (The leakage current is approx. 12 mA when the impedance is 0 Ω.)
<b>Contact input</b>	Open level (transistor OFF)
	<ul style="list-style-type: none"> <li>Impedance when OFF: 100 kΩ min.</li> </ul> Use contacts which can adequately switch 5 mA at 10 V.

Note: The DC voltage must be 30 VDC max.

#### Applicable Two-wire Sensor

- Leakage current: 1.5 mA max.
- Switching capacity: 5 mA min.
- Residual voltage: 3 VDC max.
- Operating voltage: 10 VDC

# H7CZ

## Nomenclature

Display Section
1. Key Protect Indicator
2. Control Output Indicator
3. Reset Indicator
4. Present Value (Main Display) (Character height: 10 mm)
5. Set value (Sub-display) (Character height: 6 mm)

Character Size  
for Main Display



Character Size  
for Sub-display

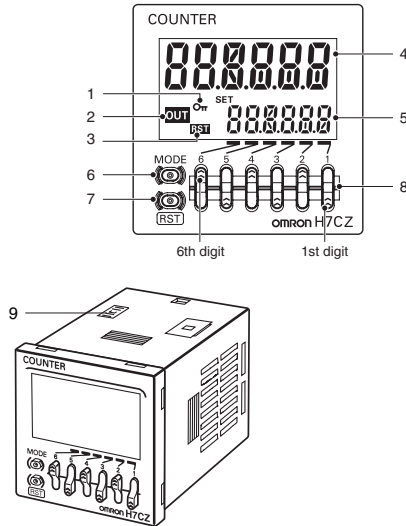
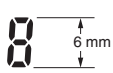

### Operation Keys

- 6. Mode Key  
(Changes modes and setting items.)
- 7. Reset Key
- 8. Up Keys [1] to [6]

### Switches

- 9. Key-protect Switch  
(Default setting) OFF ← ON  
(Disable) (Enable)

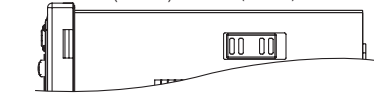

## Dimensions

(Unit: mm)

### Counters

#### H7CZ-L8/-L8D1 (Flush Mounting/Surface Mounting Models)

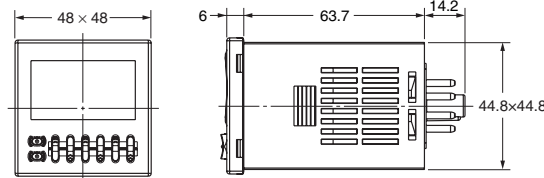

#### Panel Cutouts

Panel cutouts are as shown below. (according to DIN43700).

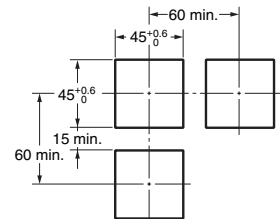

#### Dimensions with Flush Mounting Adapter

##### H7CZ-L8/-L8D1 (Adapter and Waterproof Packing Ordered Separately)

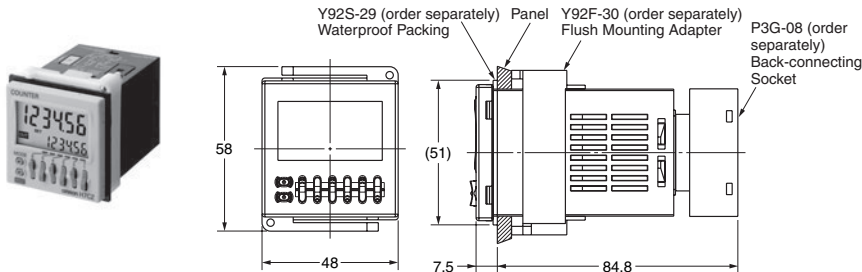

- Note:**
- The mounting panel thickness should be 1 to 5 mm.
  - To allow easier operation, it is recommended that Adapters be mounted so that the gap between sides with hooks is at least 15 mm (i.e., with the panel cutouts separated by at least 60 mm).
  - It is possible to horizontally mount Timers side by side. Attach the Flush Mounting Adapters so that the surfaces without hooks are on the sides of the Timers. If they are mounted side-by-side, water-resistance will be lost.

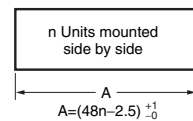

With Y92A-48F1 attached.

$$A = (48n - 2.5 + (n-1) \times 4) \pm 0.1$$

With Y92A-48 attached.

$$A = (51n - 5.5) \pm 0.1$$

#### Dimensions with Front Connecting Socket

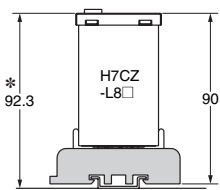

P2CF-08(-E) (order separately)  
Front Connecting Socket

\* These dimensions depend on the kind of DIN Track. (Reference value)

## Accessories (Order Separately)

**Note:** Depending on the operating environment, the condition of resin products may deteriorate, and may shrink or become harder. Therefore, it is recommended that resin products are replaced regularly.

### Soft Cover Y92A-48F1

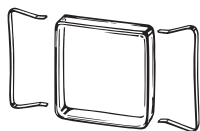

### Hard Cover Y92A-48

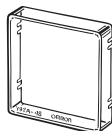

### Protecting the Counter in Environments Subject to Oil

The H7CZ's panel surface is water-resistive (conforming to IP□6, UL Type 4X) and so even if drops of water penetrate the gaps between the keys, there will be no adverse effect on internal circuits. If, however, there is a possibility of oil being present on the operator's hands, use the Soft Cover. The Soft Cover ensures protection equivalent to IP54F against oil. Do not, however, use the H7CZ in locations where it would come in direct contact with oil.

### Flush Mounting Adapter Y92F-30

Order this Flush Mounting Adapter separately if it is required.

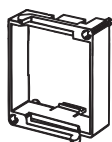

### Waterproof Packing Y92S-29



Order this Waterproof Packing separately if it is required. The Waterproof Packing can be used to achieve IP66 protection.

The Waterproof Packing will deteriorate, harden, and shrink depending on the application environment. To ensure maintaining the IP□6, UL Type 4X waterproof level, periodically replace the Waterproof Packing. The periodic replacement period will depend on the application environment. You must confirm the proper replacement period. Use 1 year or less as a guideline. If the Waterproof Packing is not replaced periodically, the waterproof level will not be maintained. It is not necessary to mount the Waterproof Packing if waterproof construction is not required.

## Connection Sockets Front Connecting Socket

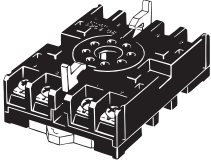
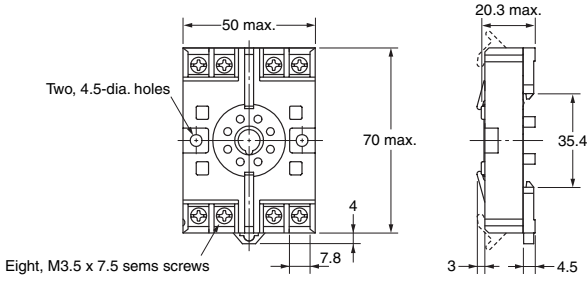
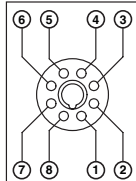
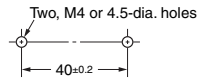
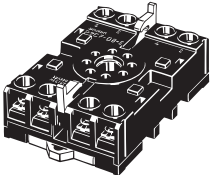
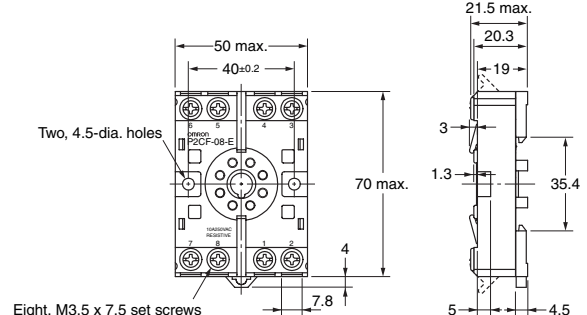
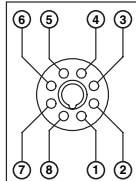
Model	Dimensions	Terminal arrangement and internal connections	Mounting hole dimensions
<b>P2CF-08</b> 			 <p><b>Note:</b> The Socket can also be mounted to DIN track.</p>
<b>P2CF-08-E (Finger Safe Terminal)</b> 		 <p>(Top View)</p>	

**Note:** Round crimp terminals cannot be used on Finger-safe Sockets. Use forked crimp terminals.

## Back-connecting Sockets

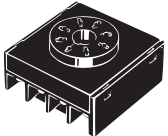
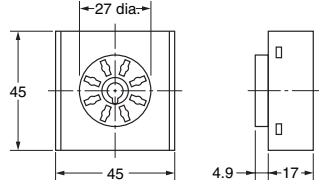
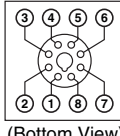
Model	Dimensions	Terminal arrangement and internal connections
<b>P3G-08</b> 		 <p>(Bottom View)</p>

**Note:** A Y92A-48G Terminal Cover can be used with the Socket to create a finger-safe construction.

## Terminal Covers for P3G-08 Back-connecting Socket

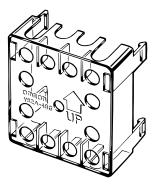
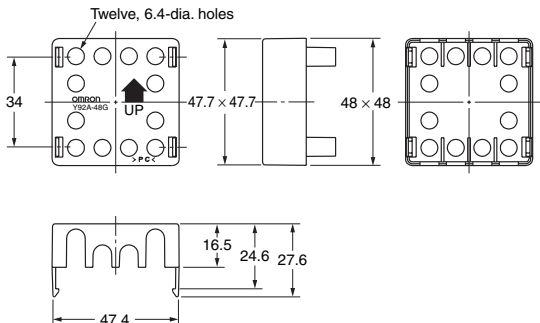
Model	Dimensions
<b>Y92A-48G</b> 	

**Note:** The Terminal Cover can be used with a Back-mounting Socket (P3G-08) to create a finger-safe construction.



**Optional Products for Track Mounting**

**Mounting Track**

PFP-100N  
PFP-50N

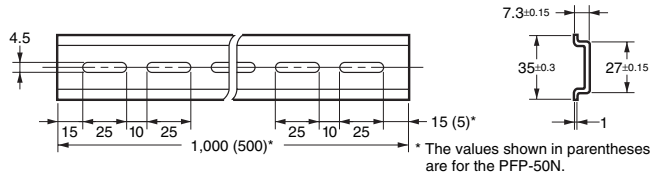
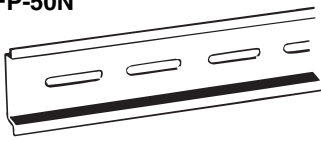

**Mounting Track**

PFP-100N2

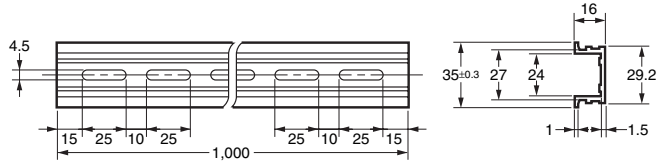
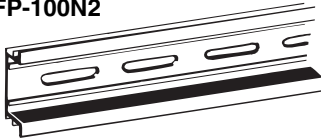

**End Plate**

PFP-M

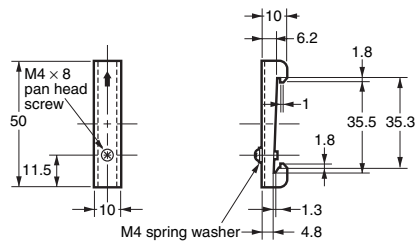

**Spacer**

PFP-S

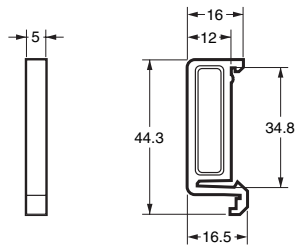
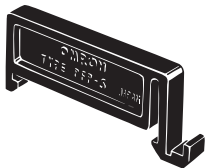

**Note:** Order Spacers in increments of 10.

Change to Function Setting Mode.

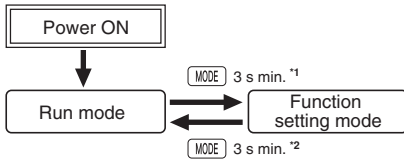

For details on operations and display in run mode, refer to page 13. The display depends on the selected configuration.

- \*1. If the mode is switched to the function setting mode during operation, operation will continue.
- \*2. Changes made to settings in function setting mode are enabled for the first time when the mode is changed to run mode. Also, when settings are changed, the counter is reset (present value initialized and output turned OFF) on returning to run mode.

The characters displayed in reverse video are the default settings.

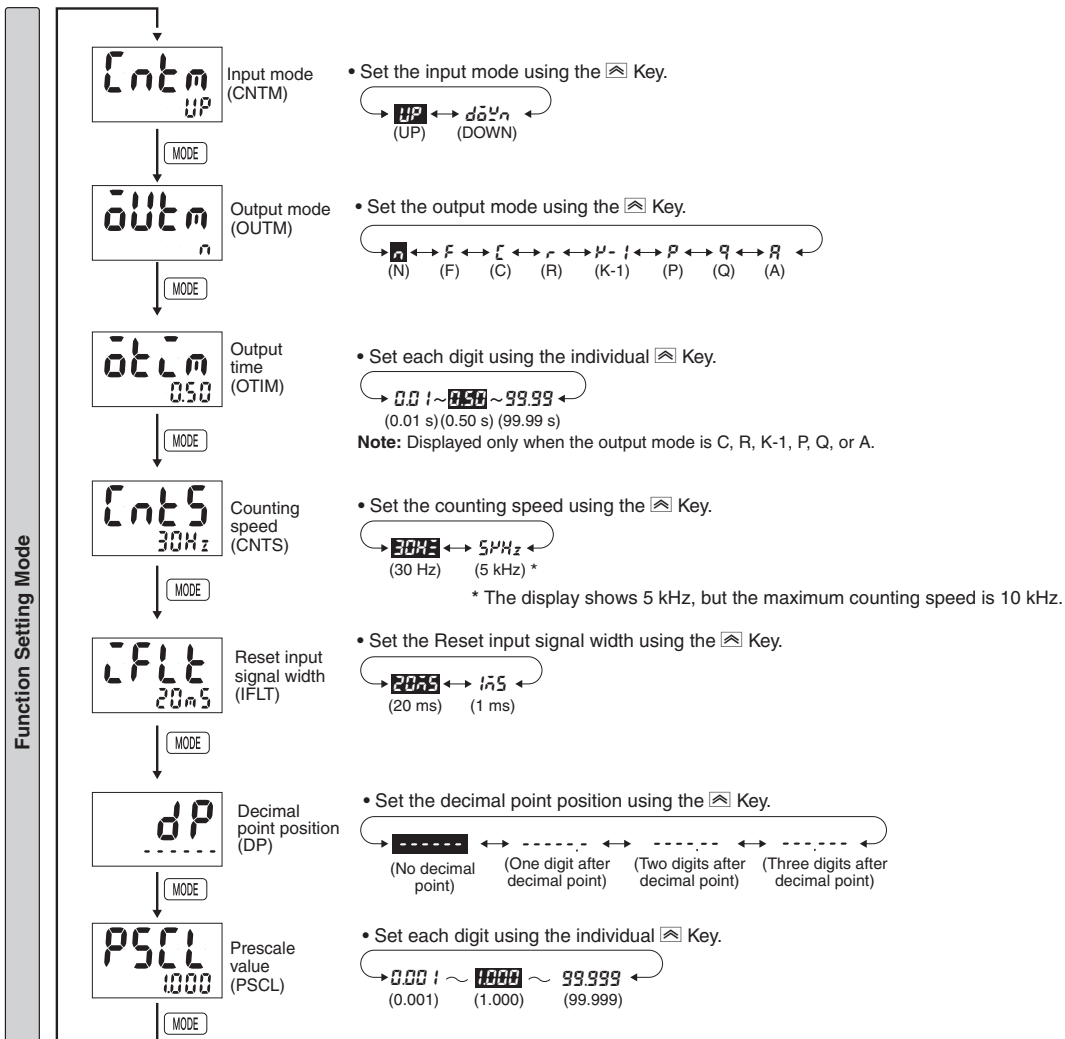

From next page To next page

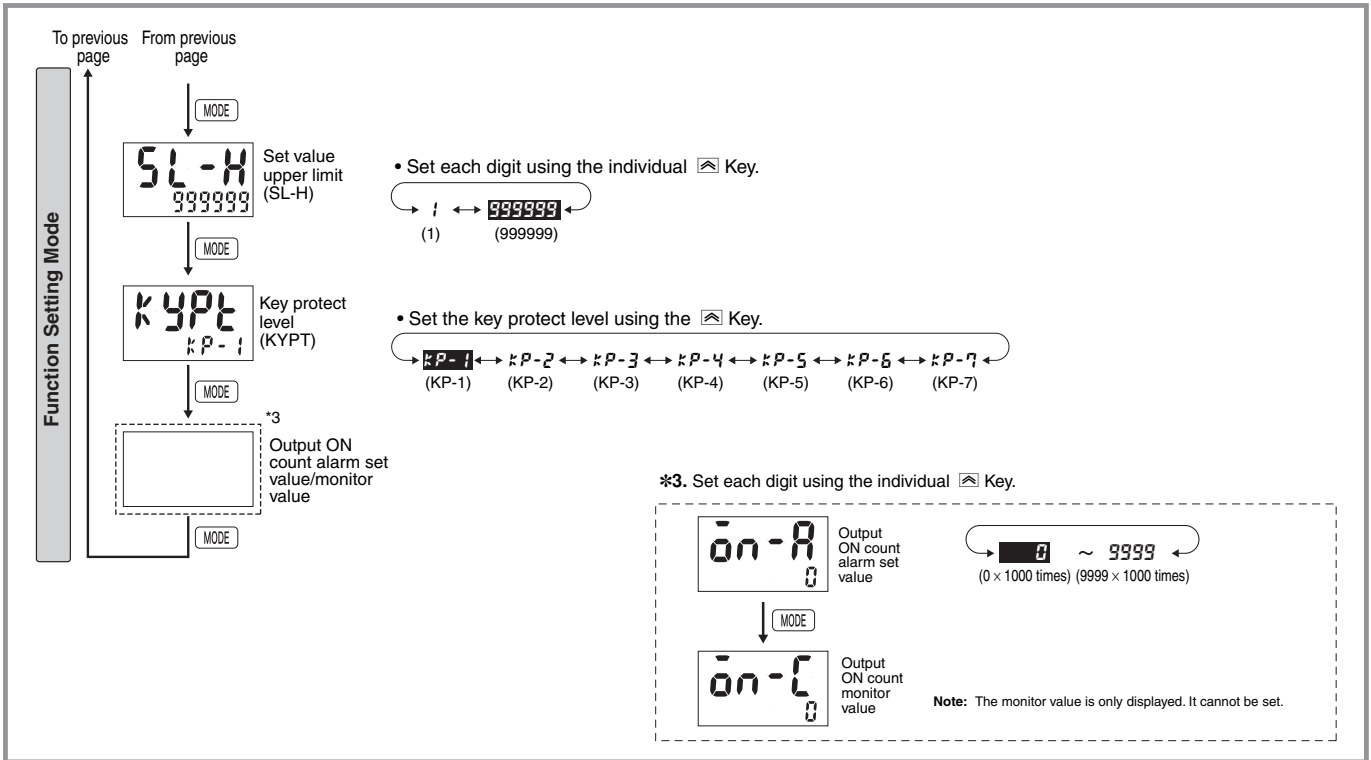

## Explanation of Functions

### Input Mode (UP/DOWN)

Set increment mode (UP) or decrement mode (DOWN) as the input mode.

### Output Mode (N, F, C, R, K-1, P, Q, and A)

Set the way that control output for the present value is output. The possible settings are N, F, C, R, K-1, P, Q, and A.

### One-shot Output Time (0.01 to 99.99 s)

Set the one-shot output time (0.01 to 99.99 s) for control output. One-shot output can be used only when C, R, K-1, P, Q, or A is selected as the output mode.

### Counting Speed (30 Hz/5 kHz)

Set the maximum counting speed (30 Hz/5 kHz) for count inputs.

### Reset Input Signal Width (20 ms/1 ms)

Set the reset input signal width (20 ms/1 ms) for reset inputs. If contacts are used for the input signal, set the input signal width to 20 ms. Processing to eliminate chattering is performed for this setting.

### Decimal Point Position (0 to 9)

Decide the decimal point position for the present value.

### Prescale Value (0.001 to 99.999)

Pulses input to the counter are converted according to the specified prescale value.

(Setting range: 0.001 to 99.999 for 6-digit models.)

Example: To display the feed distance for systems that output 25 pulses for a feed length of 0.5 m in the form □□.□□ m:

1. Set the decimal point position to 2 decimal places.
2. Set the prescale value to 0.02 (0.5 ÷ 25).

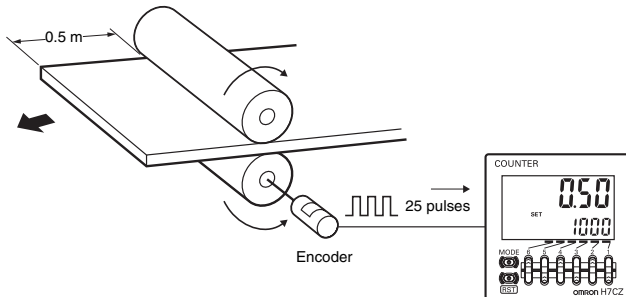

- Observe the following points when setting a prescale value.
  - Set the set value to a value less than {Maximum countable value – Prescale value}.
  - Example: If the prescale value is 1.25 and the counting range is 0.000 to 999.999, set the set value to a value less than 998.749 (= 999.999 – 1.25).
  - If the set value is set to a value greater than this, output will not turn ON.
- Output will turn ON, however, if a present value overflow occurs (FFFFFF).

**Note:** If the prescale value setting is incorrect, a counting error will occur. Check that the settings are correct before using this function.

### Set Value Upper Limit (0 to 999999)

Set the upper limit for the set value when it is set in run mode. The setting can be made from 1 to 999999 for 6-digit models.

### Key Protect Level (0 to 9)

Set the key protect level. Refer to *Key Protect Level* on page 16.

### Output ON Count Alarm Set Value (0 to 9999)

Set the alarm value for the output ON count. The limit can be set to between 0 × 1000 (0 times) and 9999 × 1000 (9,999,000 times). Only the underlined values are set. The alarm will be disabled if 0 is set.

If the total ON count of the output exceeds the alarm set value,  $\text{E3}$  will be displayed on the Timer to indicate that the output ON count alarm value was exceeded. Refer to *Self-diagnostic Function* on page 16 for information on the  $\text{E3}$  display.

### Output ON Count Monitor Value (0 to 9999)

The monitor value is only displayed. It cannot be set. The output ON count will be 1,000 times the displayed value.

## Operation in Run Mode

- Set values for each digit as required using the  Key.

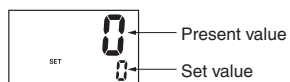

- **Present Value**  
Shows the present count value.
- **Set Values**  
Set the set values.  
When the present value reaches the set value, a signal is output according to the specified output mode.

## Input Modes and Present Value I/O Functions for Counter Operation

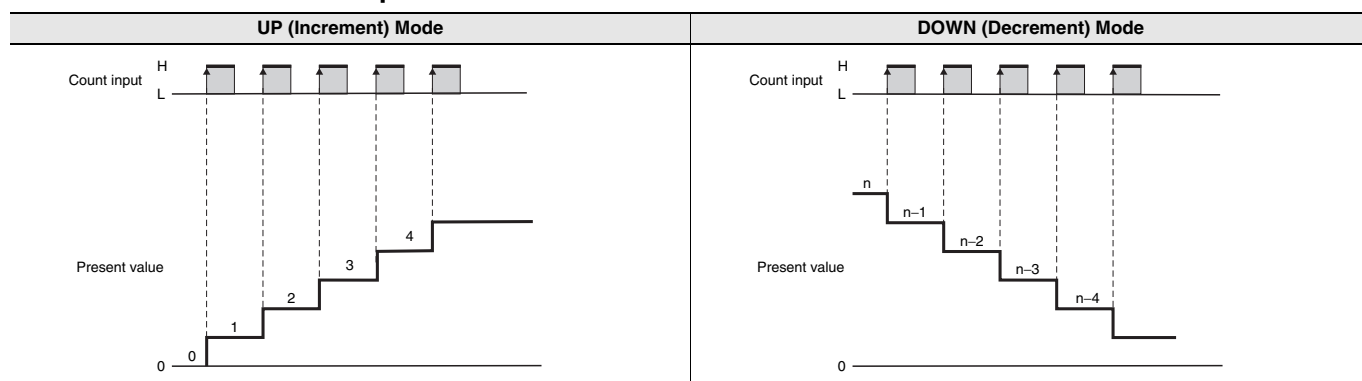



\* Counting starts when the count input is turned ON after turning ON the power.

**Note: 1.** The meaning of the H and L symbols in the tables is explained below.

Symbol Input method	No-voltage input (NPN input)
H	Short-circuit
L	Open

Input/Output Mode Settings

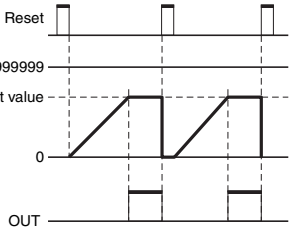
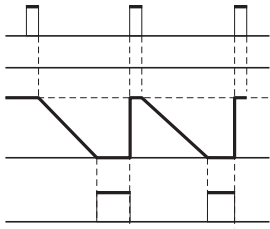
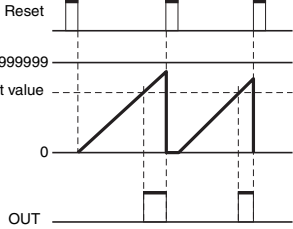
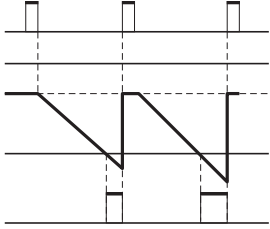
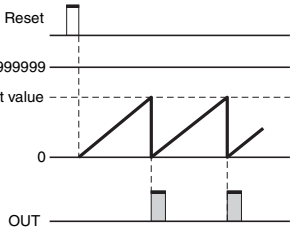
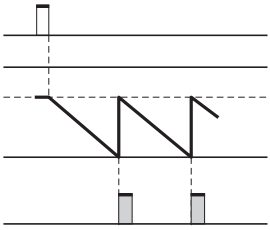
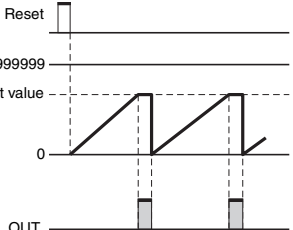
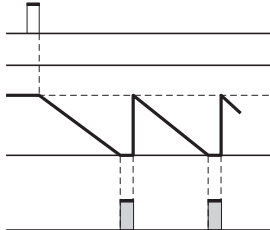
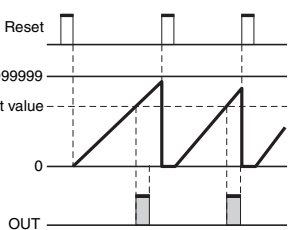
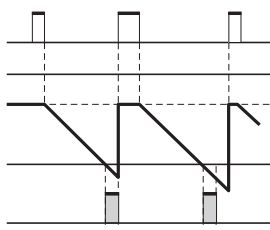

 (The one-shot output time can be set in the range 0.01 to 99.99s.)  
 Self-holding output    One-shot

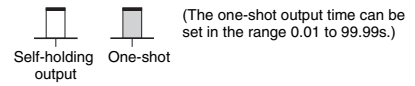
		Input mode		Operation after count completion
		UP	DOWN	
Output mode setting	N			The outputs and present value display are held until reset is input.
	F			The present value display continues to increase/decrease. The outputs are held until reset is input.
	C			As soon as the count reaches SV, the present value display returns to the reset start status. The present value display does not show the present value upon count-up. The outputs repeat one-shot operation.
	R			The present value display returns to the reset start status after the one-shot output time. The outputs repeat one-shot operation.
	K-1			The present value display continues to increase/decrease.



		Input mode		Operation after count completion
		UP	DOWN	
Output mode setting	P			<p>The present value display does not change during the one-shot output time period, but the actual count returns to the reset start status. The output will return to one-shot mode. The outputs repeat one-shot operation.</p>
	Q			<p>The present value continues to increase/decrease for the one-shot output time, but returns to the reset start status after the one-shot output time has elapsed. The outputs repeat one-shot operation.</p>
	A			<p>The present value display and OUT self-holding output is held until reset is input.</p>

- Note:**
1. When the present value reaches 999999, it returns to 0.
  2. Counting cannot be performed during reset input.
  3. If reset is input while one-shot output is ON, one-shot output turns OFF.
  4. If there is power failure while output is ON, output will turn ON again when the power supply has recovered.  
For one-shot output, output will turn ON again for the duration of the output time setting once the power supply has recovered.
  5. Do not use the counter function in applications where the count may be completed (again) while one-shot output is ON.
  6. The setting range is 0 to 999,999.

## Key Protect Level

It is possible to prevent setting errors by prohibiting the use of certain operation keys by specifying the key protect level (KP-1 to KP-7) when the key-protect switch is set to ON.

The key protect level is set in the function setting mode. The key protect indicator is lit when the key-protect switch is ON.

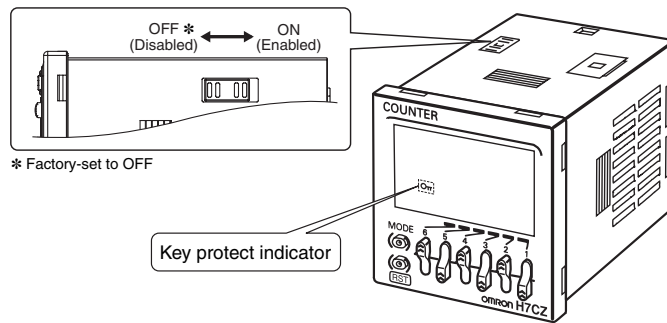

Level	Description	Details		
		Changing modes*	Reset Key	Up Keys
KP-1 (default setting)		Invalid	Valid	Valid
KP-2		Invalid	Invalid	Valid
KP-3		Invalid	Valid	Invalid
KP-4		Invalid	Invalid	Invalid
KP-5		Invalid	Invalid	Invalid
KP-6		Invalid	Valid	Valid
KP-7		Invalid	Invalid	Valid

\* Changing mode to function setting mode.

## Self-diagnostic Function

The following displays will appear if an error occurs.

Main display	Sub-display	Description	Output status	Correction method	Set value after reset
---- *1	No change	Present value underflow *2	No change	Either press the Reset Key or turn ON reset input.	No change
FFFF *1	No change	Present value overflow	No change	Either press the Reset Key or turn ON reset input.	No change
E1	Not lit	CPU error	OFF	Either press the Reset Key or reset the power supply.	No change
E2	Not lit	Memory error (RAM)	OFF	Turn ON the power again.	No change
E2	5U <sub>n</sub>	Memory error (EEPROM) *3	OFF	Reset Key	Factory setting
E3 *4	No change	Output Counter Overflow	No change	Reset Key *5	No change

\*1. Display flashes.(1-second cycles)

\*2. This occurs if the present value or total count value falls below -99999.

\*3. This includes times when the life of the EEPROM has expired.

\*4. The normal display and E3 will appear alternately.

When the Reset Key is pressed, E3 will not be displayed even if the alarm set value is exceeded.

(Monitoring is possible, however, because the counter will continue without the output ON count being cleared.)

\*5. This is displayed if the alarm value setting for either of the two outputs is exceeded if a model with two outputs is used. The total ON count will not be cleared by using the Reset Key.



## Safety Precautions for All H7CZ Series (Common)

### ⚠ CAUTION

Do not allow pieces of metal, wire clippings, or fine metallic shavings or fillings from installation to enter the product. Doing so may occasionally result in electric shock, fire, or malfunction.



Minor injury due to explosion may occasionally occur. Do not use the Counter where subject to flammable or explosive gas.



Fire may occasionally occur. Tighten the terminal screws to the rated torque.

P2CF Socket terminals: 4.4 lb-in (0.5 N-m)



Minor injury due to electric shock may occasionally occur. Do not touch any of the terminals while power is being supplied. Be sure to mount the terminal cover after wiring.



The life expectancy of the output relay varies considerably according to its usage. Use the output relay within its rated load and electrical life expectancy. If the output relay is used beyond its life expectancy, its contacts may become fused or there may be a risk of fire. Also, be sure that the load current does not exceed the rated load current and when using a heater, be sure to use a thermal switch in the load circuit.



Minor electric shock, fire, or malfunction may occasionally occur. Do not disassemble, modify, or repair the Counter or touch internal components.



### Precautions for Safe Use

- The panel surface of the H7CZ is water-resistant (conforming to NEMA4, IP66, UL Type 4X (Indoor Use Only). To protect the internal circuits from water penetration through the space between the H7CZ and operating panel, waterproof packing is included. Attach the Y92F-30 Adapter with sufficient pressure with the reinforcing screws so that water does not penetrate the panel.

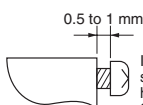

It is recommended that the space between the screw head and the Adapter be 0.5 to 1 mm.

- When mounting the Counter to a panel, tighten the two mounting screws alternately, a little at a time, so as to keep them at an equal tightness. If the panel screws are tightened unequally, water may enter the panel.
- Store the Counter at the specified temperature. If the Counter has been stored at a temperature of less than  $-10^{\circ}\text{C}$ , allow the Counter to stand at room temperature for at least 3 hours before use.
- Mounting the Counter side-by-side may reduce the life expectancies of internal components.
- Use the Counter within the specified ranges for the ambient operating temperature and humidity.
- Do not use in the following locations:
  - Locations subject to sudden or extreme changes in temperature.
  - Locations where high humidity may result in condensation.
- Do not use the Counter outside of the rated ranges for vibration, shock, water exposure, and oil exposure.
- Do not use this Counter in dusty environments, in locations where corrosive gasses are present, or in locations subject to direct sunlight.
- Install the Counter well away from any sources of static electricity, such as pipes transporting molding materials, powders, or liquids.

- Internal elements may be destroyed if a voltage outside the rated voltage range is applied.
- Be sure that polarity is correct when wiring the terminals.
- Separate the Counter from sources of noise, such as devices with input signals from power lines carrying noise, and wiring for I/O signals.
- Do not connect more than two crimp terminals to the same terminal.
- Up to two wires of the same size and type can be inserted into a single terminals.
- Use the specified wires for wiring. Applicable Wires: AWG 18 to AWG 22, solid or twisted, copper
- Install a switch or circuit breaker that allows the operator to immediately turn OFF the power, and label it to clearly indicate its function.
- Approximately 14 V is output from the input terminals. Use a sensor that contains a diode.

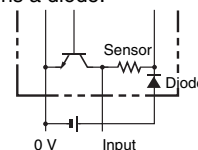

- Use a switch, relay, or other contact so that the rated power supply voltage will be reached within 0.1 seconds. If the power supply voltage is not reached quickly enough, the Counter may malfunction or outputs may be unstable.
- Use a switch, relay, or other contact to turn the power supply OFF instantaneously. Outputs may malfunction and memory errors may occur if the power supply voltage is decreased gradually.
- When changing the set value during operation, because the H7CZ uses a constant read-in system, output will turn ON if the set value is equal to the present value.
- When changing the comparison value during operation, because the H7CZ uses a constant read-in system, the output status will change if the comparison value is changed to a value on the other side of the present value.
- Do not use organic solvents (such as paint thinners or benzene), strong alkali, or strong acids. They will damage the external finish.
- Confirm that indications are working normally, including the LCD. The indicator, LCD, and resin parts may deteriorate more quickly depending on the application environment, preventing normal indications. Periodic inspection and replacement are required.
- The waterproof packing may deteriorate, shrink, or harden depending on the application environment. Periodic inspection and replacement are required.

## Precautions for Correct Use

- An inrush current of approx. 10 A will flow for a short time when the power supply is turned ON. If the capacity of the power supply is not sufficient, the Counter may not start. Be sure to use a power supply with sufficient capacity.
- Maintain voltage fluctuations in the power supply within the specified operating voltage range.
- When turning the power ON and OFF, input signal reception is possible, unstable, or impossible as shown in the diagram below.

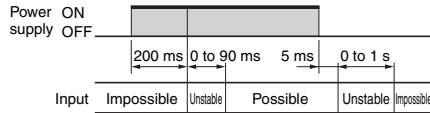

- Inrush current generated by turning ON or OFF the power supply may deteriorate contacts on the power supply circuit. Turn ON or OFF to a device with the rated current of more than 10 A.
- If the prescale value setting is incorrect, a counting error will occur. Check that the settings are correct before using this function.
- Make sure that all settings are appropriate for the application. Unexpected operation resulting in property damage or accidents may occur if the settings are not appropriate.
- Do not leave the Counter for long periods at a high temperature with output current in the ON state. Doing so may result in the premature deterioration of internal components (e.g., electrolytic capacitors).
- EEPROM is used as backup memory when the power is interrupted. The write life of the EEPROM is 100,000 writes. The EEPROM is written at the following times:
  - When the power supply is turned OFF
  - When switching from Configuration Selection Mode or Function Setting Mode to Run Mode
- Dispose of the product according to local ordinances as they apply.

## Conformance to EN/IEC Standards

- When conforming to EMC standards, refer to the information provided in this datasheet for cable selection and other conditions.
- This is a class A product. In residential areas it may cause radio interference, in which case the user may be required to take adequate measures to reduce interference.
- Basic insulation is provided between power supply and input terminals, between power supply and output terminals, and between input and output terminals.
- When double insulation or reinforced insulation is required, apply double insulation or reinforced insulation as defined in IEC 60664 that is suitable for the maximum operating voltage with clearances or solid insulation.
- Connect the input and output terminals to devices that do not have any exposed charged parts.

# Warranty and Application Considerations

## Read and Understand This Catalog

Please read and understand this catalog before purchasing the products. Please consult your OMRON representative if you have any questions or comments.

## Warranty and Limitations of Liability

### WARRANTY

OMRON's exclusive warranty is that the products are free from defects in materials and workmanship for a period of one year (or other period if specified) from date of sale by OMRON.

OMRON MAKES NO WARRANTY OR REPRESENTATION, EXPRESS OR IMPLIED, REGARDING NON-INFRINGEMENT, MERCHANTABILITY, OR FITNESS FOR PARTICULAR PURPOSE OF THE PRODUCTS. ANY BUYER OR USER ACKNOWLEDGES THAT THE BUYER OR USER ALONE HAS DETERMINED THAT THE PRODUCTS WILL SUITABLY MEET THE REQUIREMENTS OF THEIR INTENDED USE. OMRON DISCLAIMS ALL OTHER WARRANTIES, EXPRESS OR IMPLIED.

### LIMITATIONS OF LIABILITY

OMRON SHALL NOT BE RESPONSIBLE FOR SPECIAL, INDIRECT, OR CONSEQUENTIAL DAMAGES, LOSS OF PROFITS, OR COMMERCIAL LOSS IN ANY WAY CONNECTED WITH THE PRODUCTS, WHETHER SUCH CLAIM IS BASED ON CONTRACT, WARRANTY, NEGLIGENCE, OR STRICT LIABILITY.

In no event shall the responsibility of OMRON for any act exceed the individual price of the product on which liability is asserted.

IN NO EVENT SHALL OMRON BE RESPONSIBLE FOR WARRANTY, REPAIR, OR OTHER CLAIMS REGARDING THE PRODUCTS UNLESS OMRON'S ANALYSIS CONFIRMS THAT THE PRODUCTS WERE PROPERLY HANDLED, STORED, INSTALLED, AND MAINTAINED AND NOT SUBJECT TO CONTAMINATION, ABUSE, MISUSE, OR INAPPROPRIATE MODIFICATION OR REPAIR.

## Application Considerations

### SUITABILITY FOR USE

OMRON shall not be responsible for conformity with any standards, codes, or regulations that apply to the combination of products in the customer's application or use of the products.

Take all necessary steps to determine the suitability of the product for the systems, machines, and equipment with which it will be used.

Know and observe all prohibitions of use applicable to this product.

NEVER USE THE PRODUCTS FOR AN APPLICATION INVOLVING SERIOUS RISK TO LIFE OR PROPERTY WITHOUT ENSURING THAT THE SYSTEM AS A WHOLE HAS BEEN DESIGNED TO ADDRESS THE RISKS, AND THAT THE OMRON PRODUCTS ARE PROPERLY RATED AND INSTALLED FOR THE INTENDED USE WITHIN THE OVERALL EQUIPMENT OR SYSTEM.

## Disclaimers

### PERFORMANCE DATA

Performance data given in this catalog is provided as a guide for the user in determining suitability and does not constitute a warranty. It may represent the result of OMRON's test conditions, and the users must correlate it to actual application requirements. Actual performance is subject to the OMRON *Warranty and Limitations of Liability*.

### CHANGE IN SPECIFICATIONS

Product specifications and accessories may be changed at any time based on improvements and other reasons. Consult with your OMRON representative at any time to confirm actual specifications of purchased product.

### DIMENSIONS AND WEIGHTS

Dimensions and weights are nominal and are not to be used for manufacturing purposes, even when tolerances are shown.

ALL DIMENSIONS SHOWN ARE IN MILLIMETERS.

To convert millimeters into inches, multiply by 0.03937. To convert grams into ounces, multiply by 0.03527.

**OMRON Corporation** Industrial Automation Company  
Tokyo, JAPAN

Contact: [www.ia.omron.com](http://www.ia.omron.com)

**Regional Headquarters**

**OMRON EUROPE B.V.**  
Wegalaan 67-69-2132 JD Hoofddorp  
The Netherlands  
Tel: (31)2356-81-300/Fax: (31)2356-81-388

**OMRON ELECTRONICS LLC**  
One Commerce Drive Schaumburg,  
IL 60173-5302 U.S.A.  
Tel: (1) 847-843-7900/Fax: (1) 847-843-7787

**OMRON ASIA PACIFIC PTE. LTD.**  
No. 438A Alexandra Road # 05-05/08 (Lobby 2),  
Alexandra Technopark,  
Singapore 119967  
Tel: (65) 6835-3011/Fax: (65) 6835-2711

**OMRON (CHINA) CO., LTD.**  
Room 2211, Bank of China Tower,  
200 Yin Cheng Zhong Road,  
PuDong New Area, Shanghai, 200120, China  
Tel: (86) 21-5037-2222/Fax: (86) 21-5037-2200

**Authorized Distributor:**

© OMRON Corporation 2009 All Rights Reserved.  
In the interest of product improvement,  
specifications are subject to change without notice.

CSM\_7\_4\_1115  
Cat. No. M082-E1-01

Printed in Japan  
0709