

PI3PCIE3412A

3.3V, PCI Express® 3.0 2-Lane, 2:1 Mux/DeMux Switch, with Single Enable

Features

- 4 Differential Channel, 2:1 Mux/DeMux
- PCI Express® 3.0 Performance, 8.0Gbps
- Bi-directional Operation
- Low Bit-to-Bit Skew, 10ps max
- Low channel-to-channel skew, 20ps max
- Low Crosstalk: -35dB@4 GHz
- High Off Isolation: -22dB@4 GHz (8.0Gbps)
- Low insertion loss: -1.3dB@4 GHz (8.0Gbps)
- Return loss: -21dB@4 GHz
- ESD:1.5KV HBM
- Support for DP1.2 - HBR2, HBR, RBR
- Supply Voltage 3.3V
- Industrial Temperature Range: -40°C to 85°C
- Packaging (Pb-free & Green):
 - 42-contact, TQFN (ZH42), 3.5 x 9mm
 - 40-contact, TQFN (ZL40), 3 x 6mm

Description

The PI3PCIE3412A is an 8 to 4 differential channel multiplexer/demultiplexer switch. This solution can switch 2 full PCI Express® 3.0, lanes to one of two locations. Using a unique design technique, Diodes Incorporated has been able to minimize the impedance of the switch such that the attenuation observed through the switch is minimal. The unique design technique also offers a layout targeted for PCI Express signals, which minimizes the channel to channel skew as well as channel to channel crosstalk as required by the PCI Express specification.

The PI3PCIE3412A can also be used for application up to 12Gbps.

Application

Routing of PCI Express 3.0, DP1.2, USB3.0, SAS2.0, SATA3.0, XAUI, RXAUI signals with low signal attenuation.

Pin Configuration 40-Contact TQFN

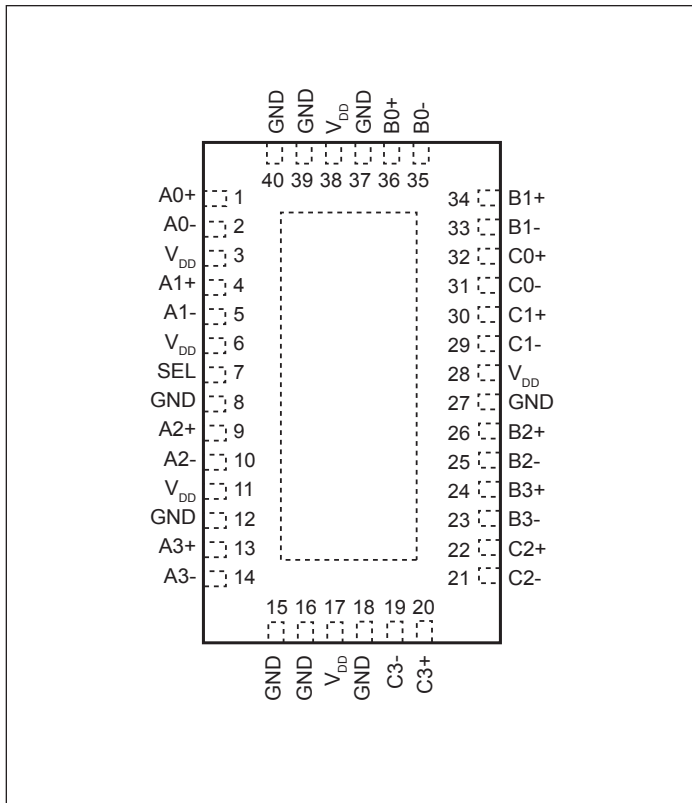

Pin Configuration 42-Contact TQFN

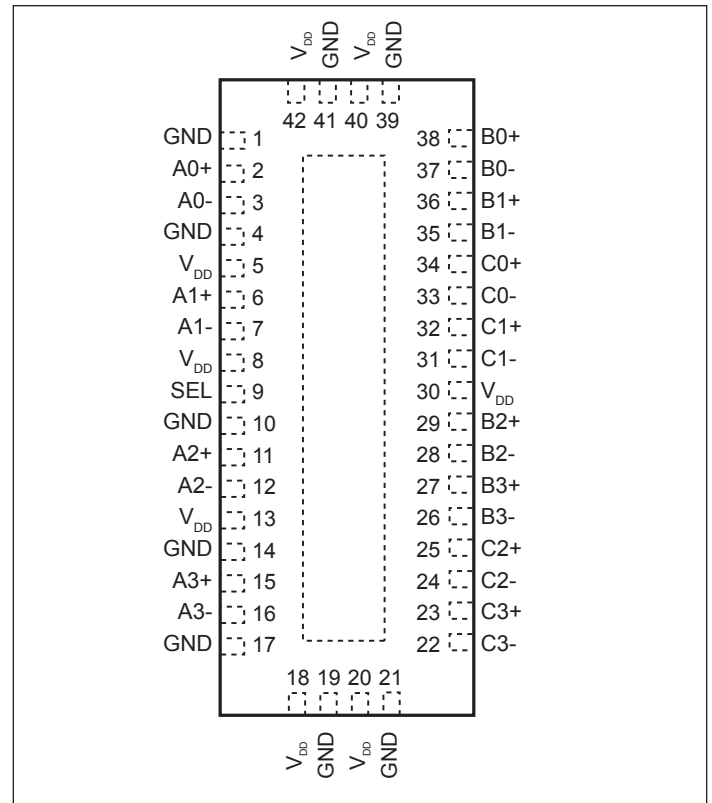

Block Diagram

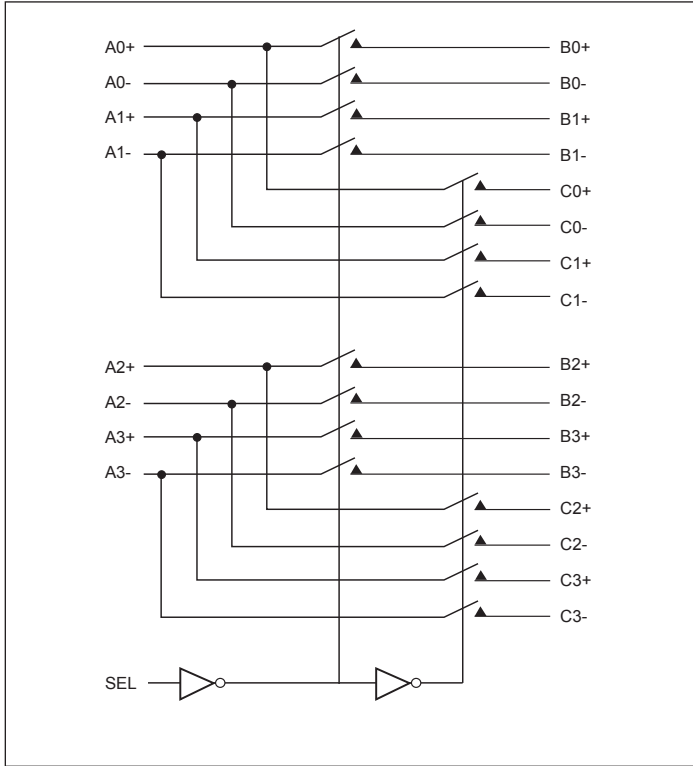

Truth Table

Function	SEL
A_N to B_N	L
A_N to C_N	H

Pin Description

Pin #		Pin Name	I/O	Description
42-TQFN	40-TQFN			
2 3	1 2	A0+ A0-	I/O	Signal I/O, Channel 0, Port A
6 7	4 5	A1+ A1-	I/O	Signal I/O, Channel 1, Port A
11 12	9 10	A2+ A2-	I/O	Signal I/O, Channel 2, Port A
15 16	13 14	A3+ A3-	I/O	Signal I/O, Channel 3, Port A
38 37	36 35	B0+ B0-	I/O	Signal I/O, Channel 0, Port B
36 35	34 33	B1+ B1-	I/O	Signal I/O, Channel 1, Port B
29 28	26 25	B2+ B2-	I/O	Signal I/O, Channel 2, Port B
27 26	24 23	B3+ B3-	I/O	Signal I/O, Channel 3, Port B
34 33	32 31	C0+ C0-	I/O	Signal I/O, Channel 0, Port C
32 31	30 29	C1+ C1-	I/O	Signal I/O, Channel 1, Port C
25 24	22 21	C2+ C2-	I/O	Signal I/O, Channel 2, Port C
23 22	20 19	C3+ C3-	I/O	Signal I/O, Channel 3, Port C
9	7	SEL	I	Operation mode Select (when SEL=0: A→B, when SEL=1: A→C)
5, 8, 13, 18, 20, 30, 40, 42	3, 6, 11, 17, 28, 38	V _{DD}	Pwr	3.3V ±10% Positive Supply Voltage
1, 4, 10, 14, 17, 19, 21, 39, 41, Center Pad	8, 12, 15, 16, 18, 27, 37, 39, 40	GND	Pwr	Power ground

Maximum Ratings

(Above which useful life may be impaired. For user guidelines, not tested.)

Storage Temperature	-65°C to +150°C
Supply Voltage to Ground Potential	-0.5V to +3.7V
Channel DC Input Voltage	-0.5V to 1.5V
DC Output Current	120mA
Power Dissipation	0.5W
SEL DC Input Voltage	-0.5V to 3.7V
Junction Temperature	125°C

Note: Stresses greater than those listed under MAXIMUM RATINGS may cause permanent damage to the device. This is a stress rating only and functional operation of the device at these or any other conditions above those indicated in the operational sections of this specification is not implied. Exposure to absolute maximum rating conditions for extended periods may affect reliability.

Electrical Characteristics

Recommended Operating Conditions

Symbol	Parameter	Conditions	Min.	Typ.	Max.	Units
V _{DD}	3.3V Power Supply		3.0	3.3	3.6	V
I _{DD}	Total current from V _{DD} 3.3V supply	SEL = 0V or V _{DD}		0.15	1	mA
V _{I/O-DIF}	Differential Voltage (differential pins)				1.6	V _{ppd}
V _{I/O-CM}	Common Mode Voltage (differential pins)		0		0.8	v
T _A	Operating temperature range		-40		85	°C

DC Electrical Characteristics for Switching over Operating Range

Parameters	Description	Test Conditions ⁽¹⁾	Min.	Typ. ⁽¹⁾	Max.	Units
V _{IH} - SEL	Input HIGH Voltage, SEL Input		2		3.6	V
V _{IL} - SEL	Input LOW Voltage, SEL Input		0		0.8	
V _{IK}	Clamp Diode Voltage	V _{DD} = Max., I _{IN} = -18mA		-0.7	-1.2	
I _{IH}	Input HIGH Current, SEL	V _{DD} = Max., V _{IN} = V _{DD}			±5	μA
I _{IL}	Input LOW Current, SEL	V _{DD} = Max., V _{IN} = 0V			±5	
I _{IN} - SEL	Input Leakage Current, SEL Input	V _{IN} = V _{IH} - SEL Max or V _{IL} - SEL Min	-10		+10	μA
I _{IH}	Input HIGH Current, A _X , B _X , C _X	V _{DD} = Max., V _{IN} = 1.5V	-10		+10	μA
I _{IL}	Input LOW Current, A _X , B _X , C _X	V _{DD} = Max., V _{IN} = 0V	-10		+10	
I _{IOZH}	HighZ HIGH Current, B _X , C _X	V _{DD} = Max., V _{IN} = 1.5V	-10		+10	μA
I _{IOZL}	HighZ LOW Current, B _X , C _X	V _{DD} = Max., V _{IN} = 0V	-10		+10	μA
C _{I/O-ON}	ON state I/O capacitance			1.5		pF
R _{ON}	ON state resistance	V _{DD} = 3.3V, I _O = 8mA, V _{IN} = 0.8V		5		Ω

Note:

1. Typical values are at V_{DD} = 3.3V, T_A = 25°C ambient and maximum loading.

Switching Characteristics

Parameters	Description	Test Conditions	Min.	Typ.	Max.	Units
tPZH, tPZL	Line Enable Time - SEL to A _N , B _N , C _N		2	20	25	ns
tPHZ, tPLZ	Line Disable Time - SEL to A _N , B _N , C _N		0.5	5	25	
t _{b-b}	Bit-to-bit skew within the same differential pair			5	10	ps
t _{ch-ch}	Channel-to-channel skew				20	ps

Dynamic Electrical Characteristics

Parameter	Description	Test Conditions	Min.	Typ. ⁽¹⁾	Max.	Units
DDIL	Differential Insertion Loss (V _{IN} = -10dBm, DC = 0V)	f= 50MHz - 1.25GHz f=1.25GHz - 2.5GHz f=2.5GHz - 4GHz f=5GHz		-0.8 -1.0 -1.3 -1.8	-1 -1.2 -1.6 -2.2	dB
DDIL _{OFF}	Differential Off Isolation	f= 50MHz - 1.25GHz f=1.25GHz - 2.5GHz f=2.5GHz - 4GHz f=5GHz	-26.3 -21.4 -17.6 -16	-32.9 -26.7 -22 -20		dB
DDRL	Differential Return Loss	f= 50MHz - 1.25GHz f=1.25GHz - 2.5GHz f=2.5GHz - 4GHz f=5GHz	-20 -18.4 -16.8 -9.6	-25 -23 -21 -12		dB
DDNEXT	Near End Crosstalk	f= 50MHz - 1.25GHz f=1.25GHz - 2.5GHz f=2.5GHz - 4GHz f=5GHz	-34.1 -30.5 -28.1 -27.2	-42.6 -38.1 -35.1 -34		dB
V _{IF}	Max Signal Frequency Range	Insertion loss 1.5dB, V _{IN} =0.623V _{pp} , DC=0V		4.0		GHz
		Insertion loss 1.5dB, V _{IN} =0.623V _{pp} , DC=0.9V		4.0		
		Insertion loss 3dB, V _{IN} =0.623V _{pp} , DC=0V		8.0		
		Insertion loss 3dB, V _{IN} =0.623V _{pp} , DC=0.9V		8.0		
BW	-3dB Bandwidth			8.2		GHz

Notes:

1. Guaranteed by design. Typical values are at V_{DD} = 3.3V, T_A = 25°C ambient and maximum loading.

PI3PCIE3412A

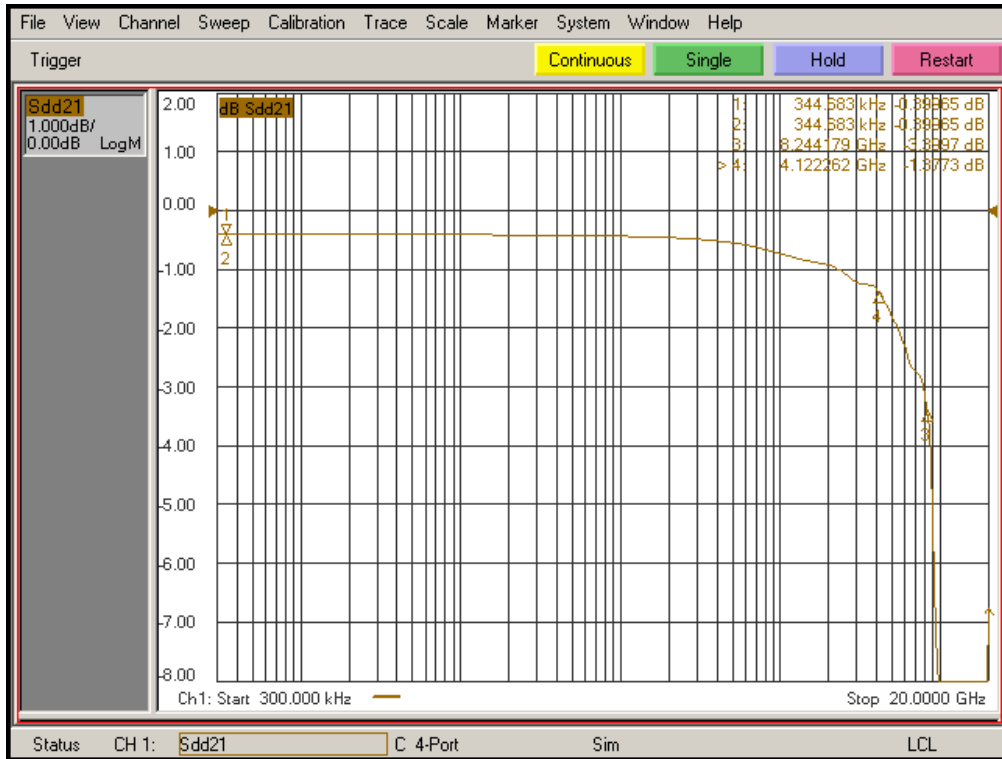

Differential Insertion Loss

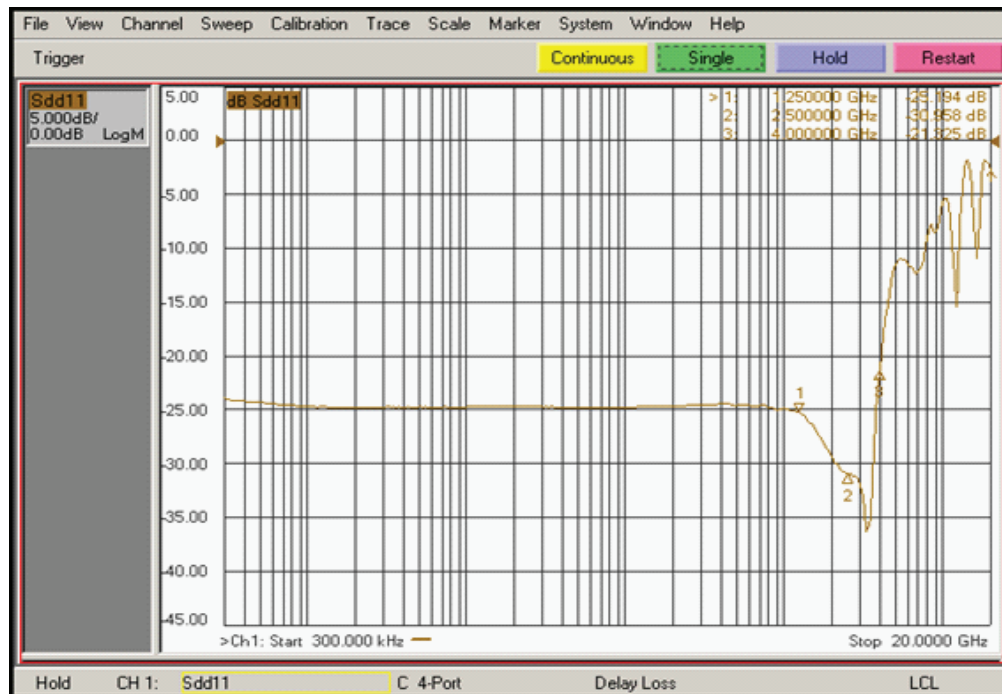

Differential Return Loss

PI3PCIE3412A

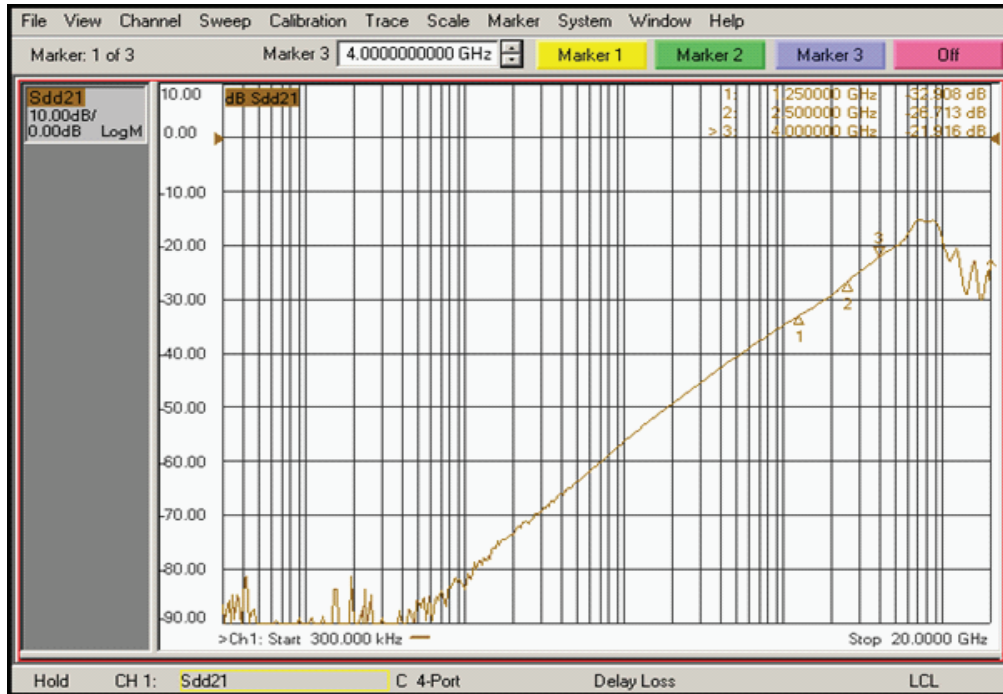

Differential Off Isolation

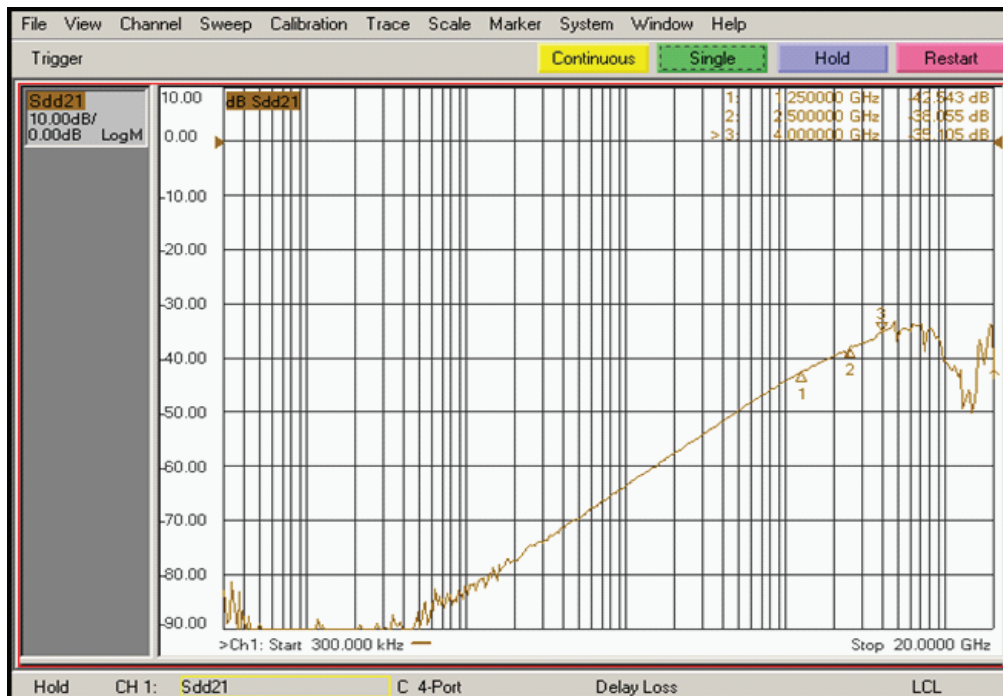

Differential Crosstalk

PI3PCIE3412A

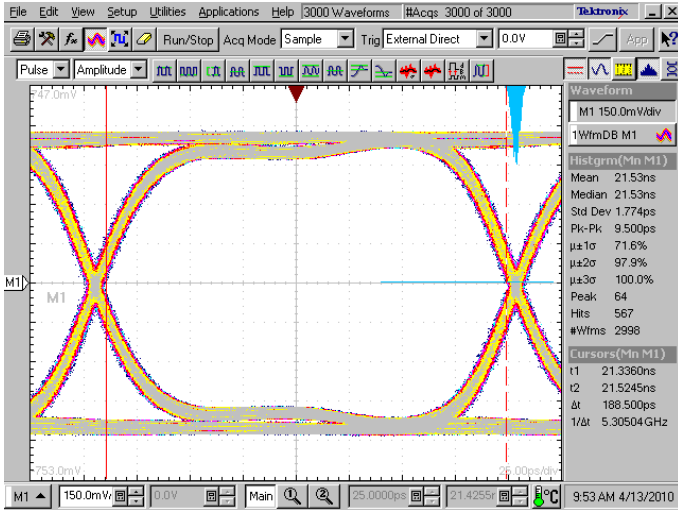

5.0 Gbps RX signal eye without PI3PCIE3412A

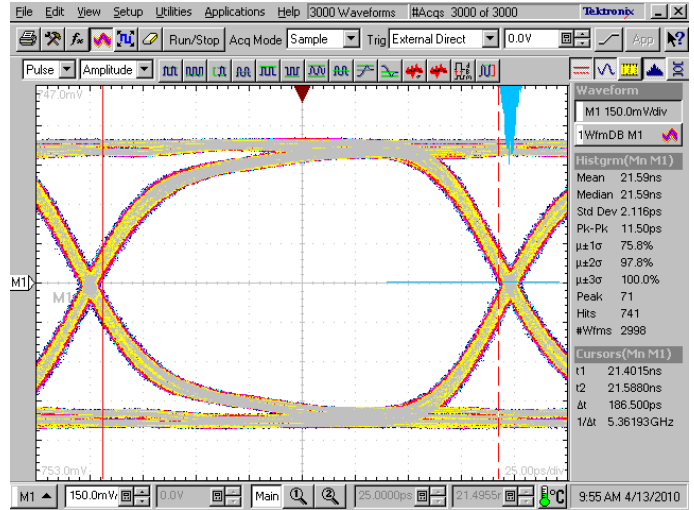

5.0 Gbps RX signal eye with PI3PCIE3412A

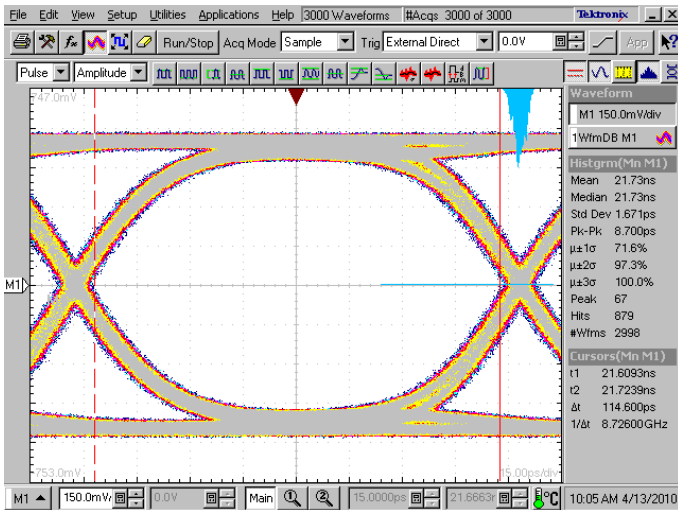

8.0 Gbps RX signal eye without PI3PCIE3412A

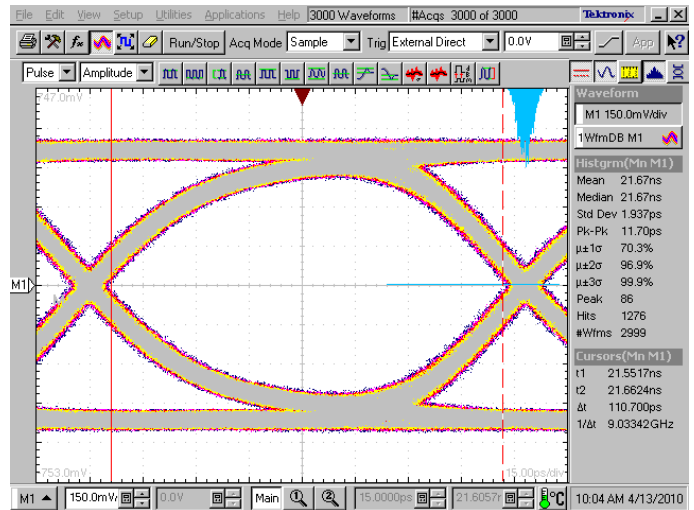

8.0 Gbps RX signal eye with PI3PCIE3412A

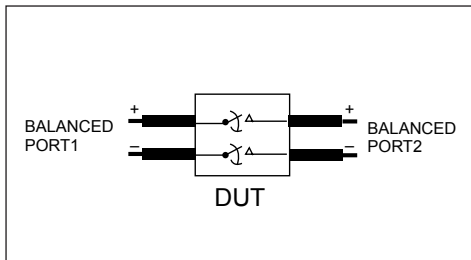

Diff. Insertion Loss and Return Test Circuit

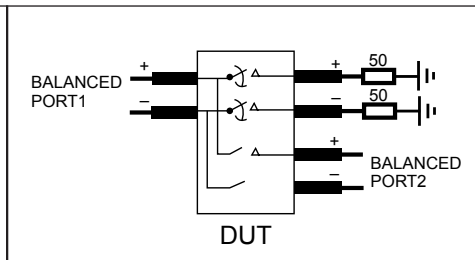

Diff. Off Isolation Test Circuit

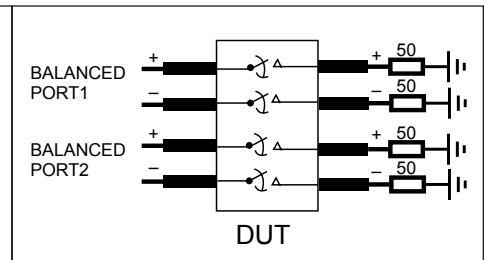

Diff. Near End Xtalk Test Circuit

Test Circuit for Electrical Characteristics⁽¹⁻⁵⁾

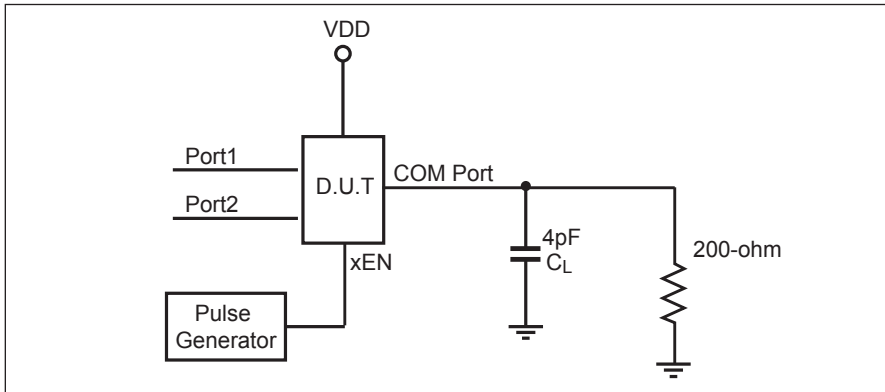

Notes:

1. C_L = Load capacitance: includes jig and probe capacitance.
2. R_T = Termination resistance: should be equal to Z_{OUT} of the Pulse Generator
3. Output 1 is for an output with internal conditions such that the output is low except when disabled by the output control.
Output 2 is for an output with internal conditions such that the output is high except when disabled by the output control.
4. All input impulses are supplied by generators having the following characteristics: $PRR \leq \text{MHz}$, $Z_O = 50\Omega$, $t_R \leq 2.5\text{ns}$, $t_F \leq 2.5\text{ns}$.
5. The outputs are measured one at a time with one transition per measurement.

Switch Positions

Test	Switch
t_{PLZ} , t_{PZL}	3.0V
t_{PHZ} , t_{PZH}	GND
Prop Delay	Open

Switching Waveforms

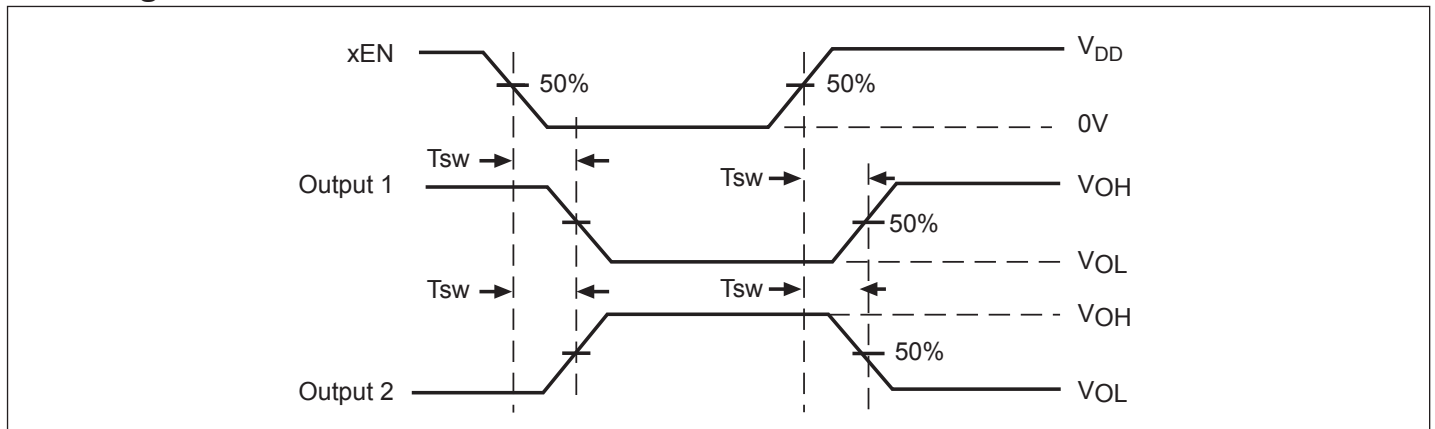

Voltage Waveforms Enable and Disable Times

PI3PCIE3412A

DP1.2 Application

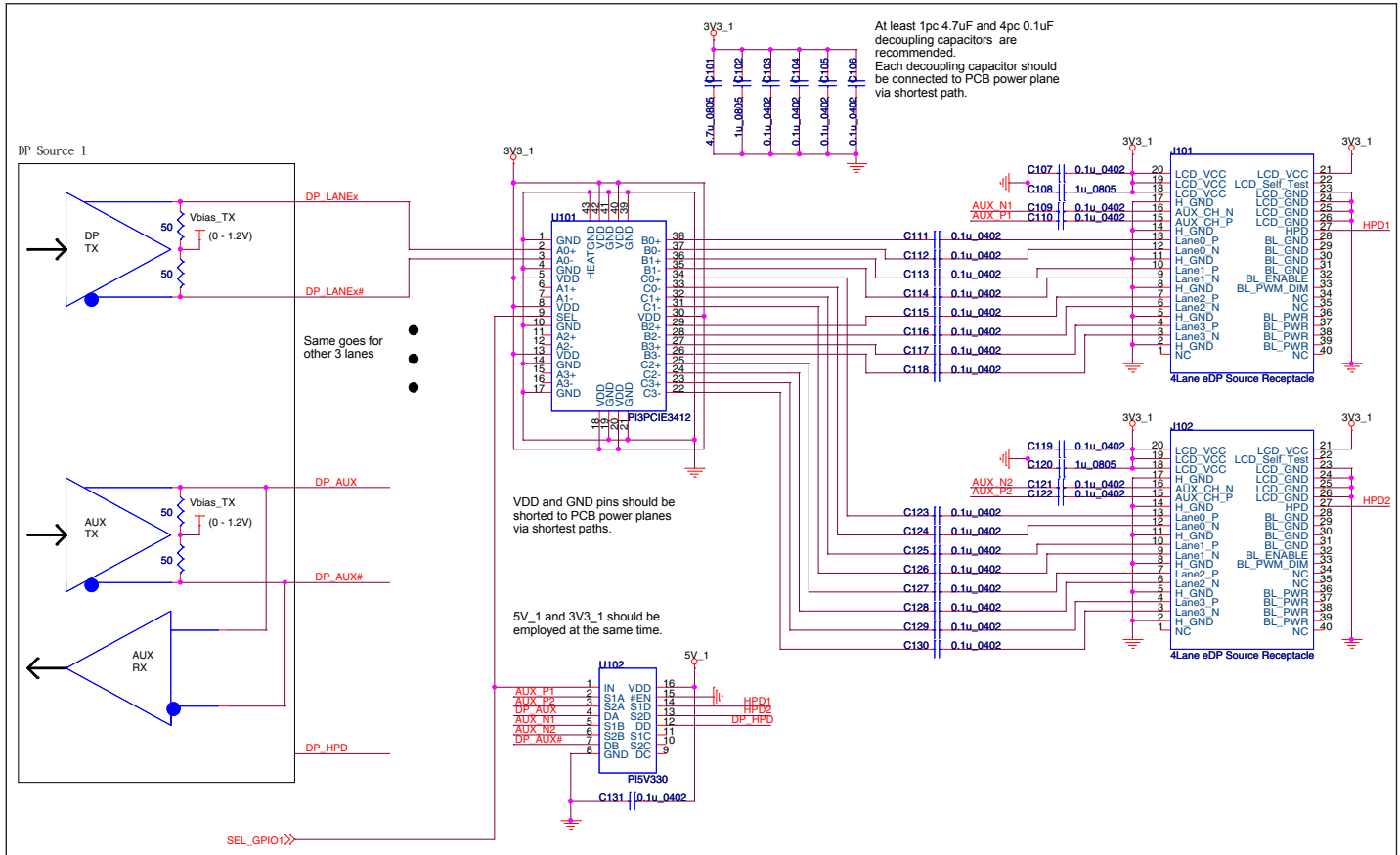

Part Marking Information

ZH Package

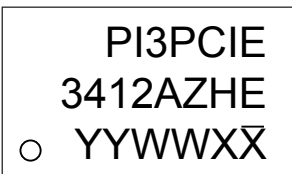

Y : Year
W : Workweek
1st X: Assembly Code
2nd X: Fab Code

ZL Package

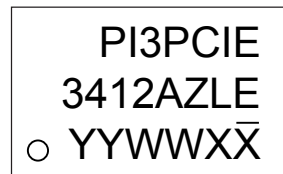

Y : Year
W : Workweek
1st X: Assembly Code
2nd X: Fab Code

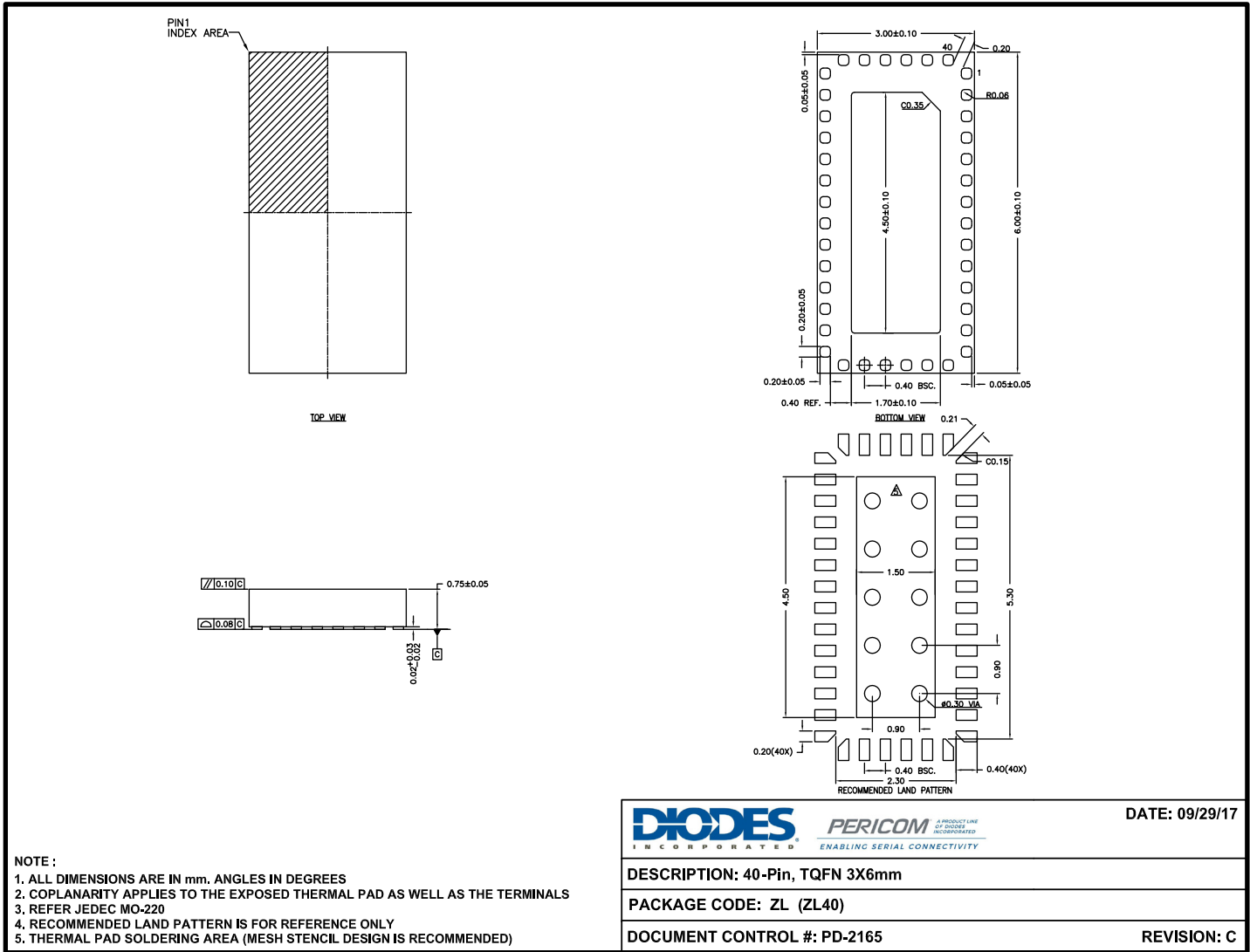

PI3PCIE3412A

Packaging Mechanical : 40-TQFN (ZL)



NOTE:

1. ALL DIMENSIONS ARE IN mm, ANGLES IN DEGREES
2. COPLANARITY APPLIES TO THE EXPOSED THERMAL PAD AS WELL AS THE TERMINALS
3. REFER JEDEC MO-220
4. RECOMMENDED LAND PATTERN IS FOR REFERENCE ONLY
5. THERMAL PAD SOLDERING AREA (MESH STENCIL DESIGN IS RECOMMENDED)

 		DATE: 09/29/17
DESCRIPTION: 40-Pin, TQFN 3X6mm		
PACKAGE CODE: ZL (ZL40)		
DOCUMENT CONTROL #: PD-2165		REVISION: C

17-0681

PI3PCIE3412A

Packaging Mechanical : 42-TQFN (ZH)

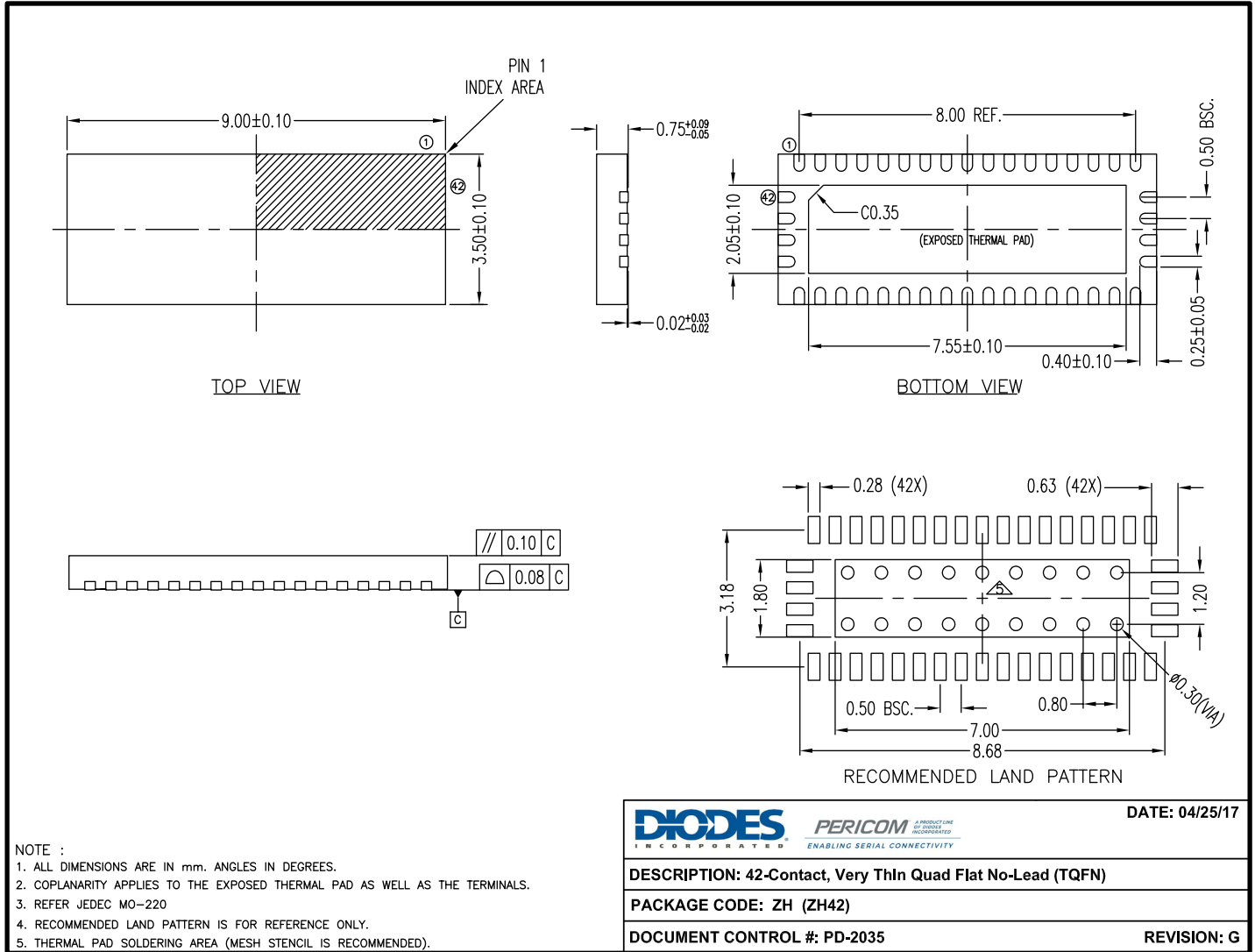

17-0266

For latest package info.

please check: <http://www.diodes.com/design/support/packaging/pericom-packaging/packaging-mechanicals-and-thermal-characteristics/>

Ordering Information

Ordering Code	Package Code	Package Description
PI3PCIE3412AZLEX	ZL	40-pin, 3x6mm(TQFN)
PI3PCIE3412AZHEX	ZH	42-contact, Very Thin Quad Flat No-Lead (TQFN)

Notes:

- Thermal characteristics can be found on the company web site at www.diodes.com/design/support/packaging/
- E = Pb-free and Green
- X suffix = Tape/Reel

IMPORTANT NOTICE

DIODES INCORPORATED MAKES NO WARRANTY OF ANY KIND, EXPRESS OR IMPLIED, WITH REGARDS TO THIS DOCUMENT, INCLUDING, BUT NOT LIMITED TO, THE IMPLIED WARRANTIES OF MERCHANTABILITY AND FITNESS FOR A PARTICULAR PURPOSE (AND THEIR EQUIVALENTS UNDER THE LAWS OF ANY JURISDICTION).

Diodes Incorporated and its subsidiaries reserve the right to make modifications, enhancements, improvements, corrections or other changes without further notice to this document and any product described herein. Diodes Incorporated does not assume any liability arising out of the application or use of this document or any product described herein; neither does Diodes Incorporated convey any license under its patent or trademark rights, nor the rights of others. Any Customer or user of this document or products described herein in such applications shall assume all risks of such use and will agree to hold Diodes Incorporated and all the companies whose products are represented on Diodes Incorporated website, harmless against all damages.

Diodes Incorporated does not warrant or accept any liability whatsoever in respect of any products purchased through unauthorized sales channel.

Should Customers purchase or use Diodes Incorporated products for any unintended or unauthorized application, Customers shall indemnify and hold Diodes Incorporated and its representatives harmless against all claims, damages, expenses, and attorney fees arising out of, directly or indirectly, any claim of personal injury or death associated with such unintended or unauthorized application.

Products described herein may be covered by one or more United States, international or foreign patents pending. Product names and markings noted herein may also be covered by one or more United States, international or foreign trademarks.

This document is written in English but may be translated into multiple languages for reference. Only the English version of this document is the final and definitive format released by Diodes Incorporated.

LIFE SUPPORT

Diodes Incorporated products are specifically not authorized for use as critical components in life support devices or systems without the express written approval of the Chief Executive Officer of Diodes Incorporated. As used herein:

A. Life support devices or systems are devices or systems which:

1. are intended to implant into the body, or

2. support or sustain life and whose failure to perform when properly used in accordance with instructions for use provided in the labeling can be reasonably expected to result in significant injury to the user.

B. A critical component is any component in a life support device or system whose failure to perform can be reasonably expected to cause the failure of the life support device or to affect its safety or effectiveness.

Customers represent that they have all necessary expertise in the safety and regulatory ramifications of their life support devices or systems, and acknowledge and agree that they are solely responsible for all legal, regulatory and safety-related requirements concerning their products and any use of Diodes Incorporated products in such safety-critical, life support devices or systems, notwithstanding any devices- or systems-related information or support that may be provided by Diodes Incorporated. Further, Customers must fully indemnify Diodes Incorporated and its representatives against any damages arising out of the use of Diodes Incorporated products in such safety-critical, life support devices or systems.

Copyright © 2016, Diodes Incorporated

www.diodes.com