

## ADJUSTABLE LOW DROPOUT VOLTAGE REGULATOR

### ■ GENERAL DESCRIPTION

The NJM2397 is adjustable low dropout voltage regulator. The output current is up to 1.5A and dropout voltage is 0.2Vtyp. at  $I_o=0.5A$ .

The NJM2397 is suitable for power module, TV, Display, car stereo and low power applications.

### ■ FEATURE

- Low Dropout Voltage                     $\Delta V_{I-O}=0.2V$  typ. at  $I_o=0.5A$
- Output Current                          $I_o(\max.)=1.5A$
- Reference Voltage                       $V_{ref}=1.29V$  typ.
- Internal Short Circuit Current Limit
- Internal Overvoltage Protection
- Internal Thermal Overload Protection
- Bipolar Technology
- Package Outline                        TO-220F(4pin)

### ■ PACKAGE OUTLINE

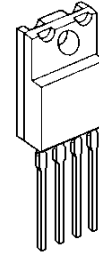

NJM2397F

### ■ PIN CONFIGURATION

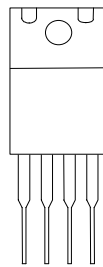

1 2 3 4

NJM2397F

### PIN FUNCTION

1.  $V_{IN}$
2.  $V_{OUT}$
3. GND
4. ADJ

### ■ EQUIVALENT CIRCUIT

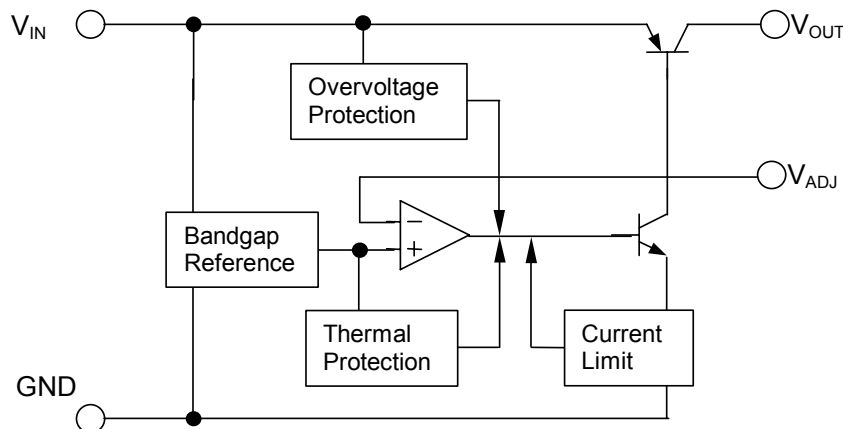

# NJM2397

## ■ ABSOLUTE MAXIMUM RATINGS

(Ta=25°C)

PARAMETER	SYMBOL	RATINGS	UNIT
Input Voltage	V <sub>IN</sub>	+35	V
Adjust terminal Voltage	V <sub>ADJ</sub>	+6	V
Output Current	I <sub>o</sub>	1.5	A
Power Dissipation	P <sub>D</sub>	18(Tc<50°C)	W
Operating Junction Temperature Range	T <sub>j</sub>	-40 to +150	°C
Operating Temperature Range	Topr	-40 to 85	°C
Storage Temperature Range	Tstg	-50 to 150	°C

## ■ ELECTRICAL CHARACTERISTICS (V<sub>IN</sub>=15V, V<sub>o</sub>=10V, I<sub>o</sub>=0.5A, R<sub>1</sub>=1kΩ, C<sub>IN</sub>=0.33uF, C<sub>o</sub>=22uF, T<sub>j</sub>=25°C)

Measurement is to be conducted is pulse testing.

PARAMETER	SYMBOL	CONDITIONS	MIN.	TYP.	MAX.	UNIT
Input Voltage	V <sub>IN</sub>		3.8	-	35	V
Output Voltage	V <sub>o</sub>		1.5	-	20	V
Reference Voltage	V <sub>ref</sub>		1.238	1.29	1.342	V
Line Regulation	$\Delta V_o / \Delta V_{IN}$	V <sub>IN</sub> =V <sub>o</sub> +1V~V <sub>o</sub> +17V	-	0.04	0.16	%/V
Load Regulation	$\Delta V_o / \Delta I_o$	V <sub>IN</sub> =V <sub>o</sub> +2V, I <sub>o</sub> =0A~1.5A	-	0.2	1.4	%/A
Average Temperature Coefficient of Output Voltage	$\Delta V_o / \Delta T$	T <sub>j</sub> =0~125°C	-	±0.02	-	%/°C
Quiescent Current	I <sub>Q</sub>	I <sub>o</sub> =0A	-	-	5	mA
Dropout Voltage	$\Delta V_{I_o}$	I <sub>o</sub> =0.5A	-	0.2	0.5	V
Ripple Rejection	RR	V <sub>in</sub> =V <sub>o</sub> +2V, e <sub>in</sub> =0.5Vrms, f=120Hz	45	55	-	dB

## ■ TEST CIRCUIT

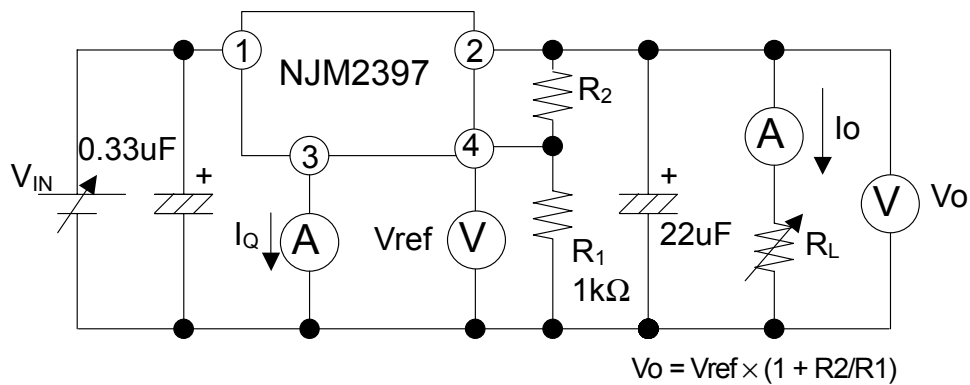

## ■ TYPICAL CHARACTERISTICS

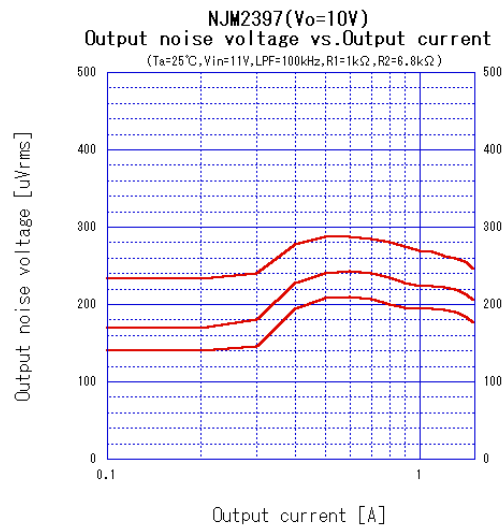
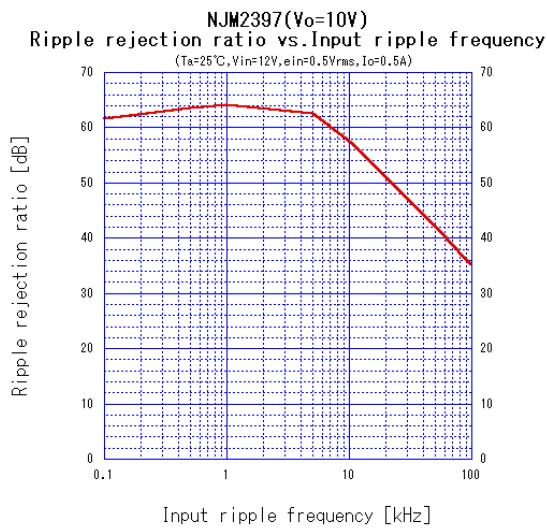
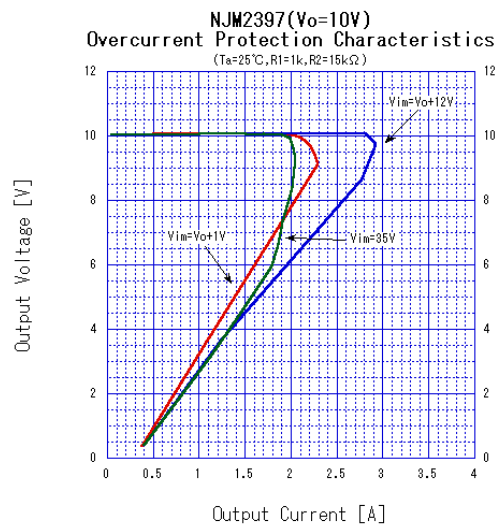
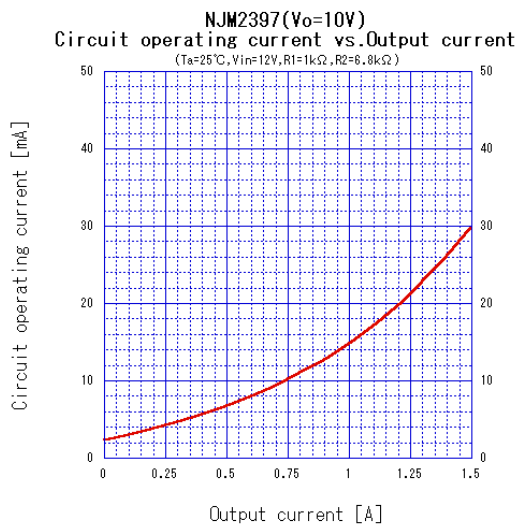
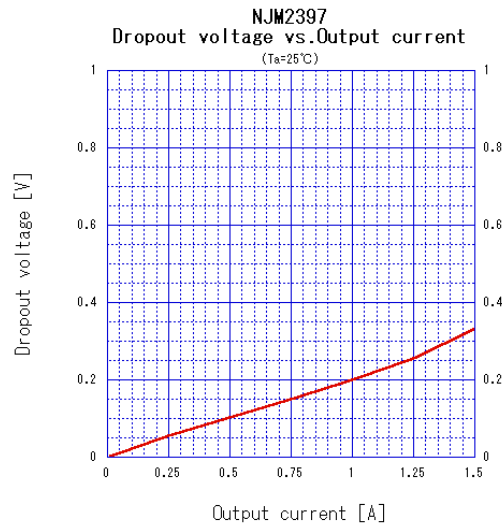
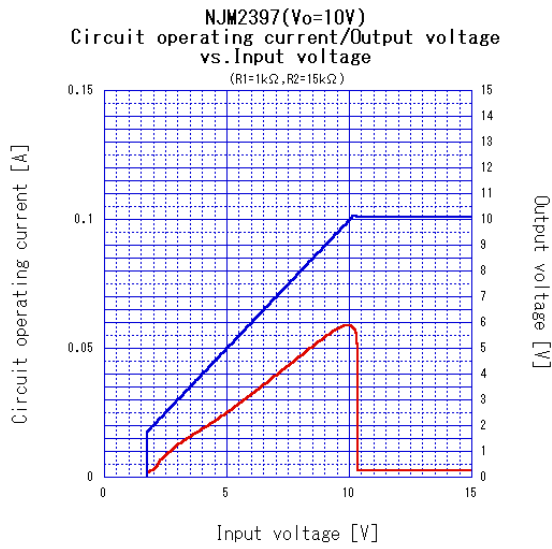

# NJM2397

## ■ TYPICAL CHARACTERISTICS

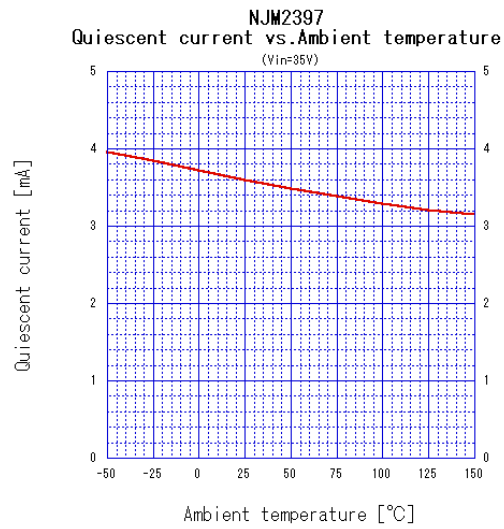
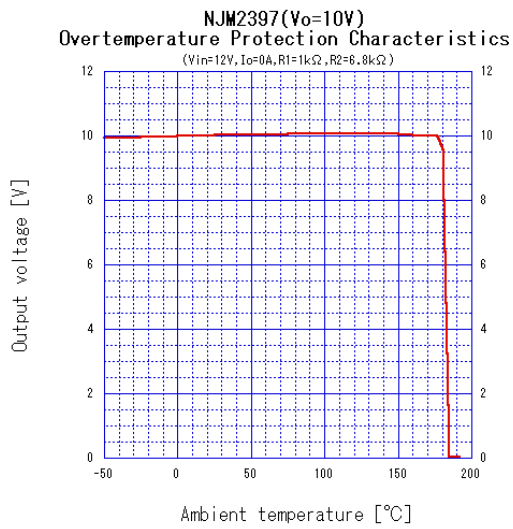
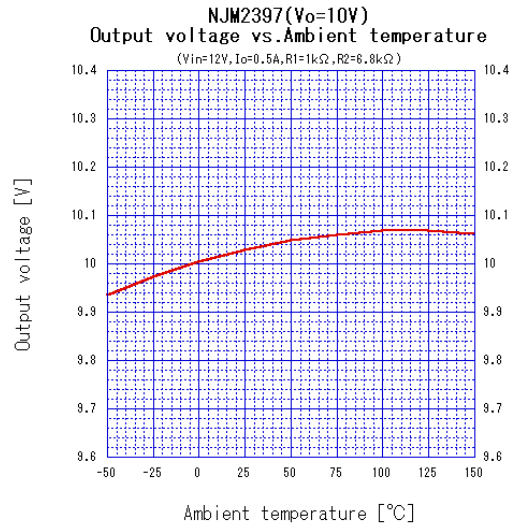
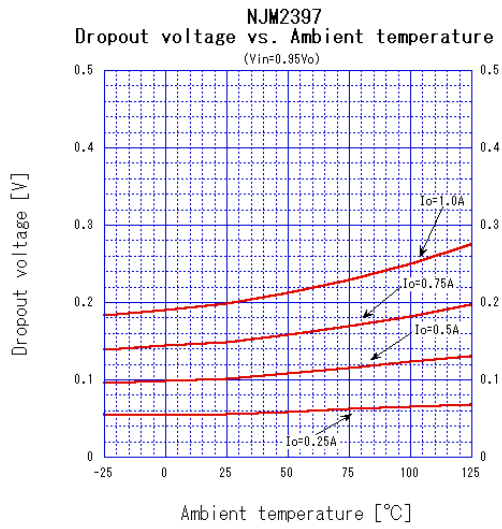

**[CAUTION]**

The specifications on this databook are only given for information, without any guarantee as regards either mistakes or omissions. The application circuits in this databook are described only to show representative usages of the product and not intended for the guarantee or permission of any right including the industrial rights.